

CATÁLOGO TARIFA  
Catalogue Price List • Catalogue Tarif

2023

Enero • January • Janvier

SISTEMAS DE ALMACENAJE Y MOBILIARIO PARA VESTUARIOS Y COLECTIVIDADES  
Racking systems and furniture for locker and communities • Systèmes de rangement et équipements pour vestiaires et collectivités

estanterías  
**JOMASI**

## Tradición familiar, más de tres generaciones

Estanterías Jomasi S.L., una empresa con una gran tradición familiar, en la que generación tras generación hemos ido creciendo e innovando. Nuestra familia lleva más de 50 años dedicada al diseño, fabricación y distribución de sistemas de almacenaje, mobiliario para vestuarios y colectividades y equipamiento comercial. En el año 1999, basados en nuestra amplia experiencia en el sector, decidimos volver a empezar de cero en el término municipal de Cuarte de Huerva (Zaragoza).

El éxito de nuestra empresa es el gran equipo humano que la compone, la inversión en medios productivos de última generación y la apuesta continua en I+D+i. La suma de estos factores nos ha permitido la entrada en nuevos mercados internacionales: Bélgica, Colombia, Etiopía, Francia, Italia, Luxemburgo, Marruecos, Países Bajos, Portugal y Senegal.

La calidad siempre ha estado en el centro de nuestras prioridades, y desde el año 2006, el Sistema de Gestión, certificado por Bureau Veritas Certification, avala nuestros procesos productivos.

Cada vez más concienciados con el cuidado del planeta, Estanterías Jomasi aplica su Sistema de Gestión Medioambiental, expedido por Bureau Veritas Certification, en todos los departamentos que integran la empresa.

En nuestro compromiso por un mundo más sostenible, hemos decidido apostar por las energías renovables, y más de la mitad de la energía que consumimos es generada por placas fotovoltaicas.

Por todas estas razones, nos apasiona nuestro trabajo y nos reinventamos todos los días para adaptarnos a las necesidades de nuestros clientes.



+34 976 504 103



info@estanteriasjomasi.com

www



estanteriasjomasi.com



## A company with a long familiar tradition, more than three generations

*Estanterías Jomasi S.L. is a Spanish company with a long familiar tradition in which generation after generation, we have been growing and innovating. For more than 50 years, our family has been dedicated to the manufacture and distribution of storage systems, furniture for changing rooms and communities and commercial equipment. In the year 1999, based on our wide experience in this sector, we decided to start from zero in Cuarte de Huerva, Zaragoza.*

*The real success of our company is the human team that composes it. Apart from the investment in productive means of the last generation and the ongoing commitment towards R & D & I. The combination of these factors has allowed us to enter new in markets like Belgium, Colombia, Ethiopia, France, Holland, Italy, Luxembourg, Morocco, Portugal and Senegal.*

*Quality has always been at the center of our priorities, and since 2006, the Quality Management System, certified by Bureau Veritas Certification, guarantees our production processes.*

*We are also a company that cares for the environment. For this reason, Estanterías Jomasi applies in all of the departments of the company the Environmental Management System granted by Bureau Veritas Certification.*

*In accordance with our commitment to a more sustainable world, we have decided to invest in renewable energies, and more than a half of the energy our factory consumes is generated by photovoltaic panels.*

*For all of these reasons, we love our work and reinvent ourselves every day with the purpose of adapting to the needs of our clients.*

## Tradition familiale, plus de trois generations

*Estanterías Jomasi S.L., est une entreprise ayant une grande tradition familiale, où génération après génération nous avons grandi et innové. Notre famille est consacrée depuis plus de 50 ans à la conception, la fabrication et la distribution de systèmes de rangement, de mobilier pour vestiaires, collectivités et d'équipements commerciaux. En 1999, sur la base de notre vaste expérience dans ce secteur, nous avons décidé de tout reprendre à zéro à la municipalité de Cuarte de Huerva (Saragosse).*

*Le succès de notre entreprise repose sur la grande équipe de personnes qui la composent, sur l'investissement dans des moyens de production de pointe et sur l'engagement continu en matière de R+D+I. La somme de ces facteurs nous a permis l'entrée des nouveaux marchés internationaux : Belgique, Colombie, Éthiopie, France, Hollande, Italie, Luxembourg, Maroc, Portugal et Sénégal.*

*La qualité a toujours été au centre de nos priorités et, depuis 2006, le système de gestion, certifié par Bureau Veritas Certification, garantit nos processus de production.*

*De plus en plus consciente de la nécessité de prendre soin de la planète, Estanterías Jomasi applique son système de gestion environnementale, délivré par Bureau Veritas Certification, dans tous les départements qui composent l'entreprise.*

*Dans le cadre de notre engagement pour un monde plus durable, nous avons décidé d'opter pour les énergies renouvelables, et plus de la moitié de l'énergie que nous consommons est générée par des panneaux photovoltaïques.*

*Pour toutes ces raisons, nous sommes passionnés par notre travail et nous nous réinventons chaque jour pour nous adapter aux besoins de nos clients.*

## CONDICIONES GENERALES

- Los **pedidos** se efectuarán vía e-mail.
- Los **plazos de entrega** indicados se entenderán como orientativos. Estanterías Jomasi S.L. no se hace responsable de ningún retraso de los materiales originado como consecuencia de causas ajenas a su voluntad, no constituyendo motivo de anulación por parte del comprador ni penalización por perjuicios que puedan derivar terceros al cliente.
- Los **pedidos inferiores a 200 €** netos sin contar el coste del transporte ni de montaje llevarán un recargo de 25 €, además de las aperturas de paquete si se da el caso.
- Cuando la mercancía viaje a **portes pagados**, Estanterías Jomasi S.L. se reserva el derecho de contratar dicho servicio con la agencia de transporte que considere más oportuno. El transporte se considera hasta la puerta del cliente, y en ningún caso, la descarga cuando se envíe por camión de ruta, ni la ubicación en el interior de las instalaciones del cliente cuando sea agencia de reparto de plaza.
- Los pedidos cuyo **importe sea inferior al acordado para portes pagados**, el importe en concepto de portes se cargará en la factura, siendo el mínimo de 21 €.
- La **reexpedición** a un domicilio distinto al del cliente conlleva un coste de 12 € por trámites de administración.
- La apertura de un paquete se considera "**empaquetado especial**" con un coste de 1,85 €/neto por paquete.
- El importe de **material montado desde fábrica no incluye la descarga ni la ubicación en las instalaciones del cliente**. Si precisa de estos servicios, consúltenos.
- La visible recepción de **material defectuoso o erróneo** deberá hacerse constar en el albarán del transporte indicando bulto dañado o pendiente de revisión, y posteriormente, en un plazo máximo de 24 horas y por escrito informar a Estanterías Jomasi S.L. De lo contrario se entenderá la aceptación de la mercancía correcta y en buen estado.
- La **devolución de mercancía** por motivos propios del cliente, no habiendo transcurrido 30 días desde la compra de dicha mercancía, Estanterías Jomasi S.L. se reserva el derecho a abonar la mercancía aplicando una desvalorización del 10%, además del coste que haya originado el transporte, tanto de ida como de vuelta.
- La **devolución de un pago** supone un incremento del 4% en el importe de la factura.
- Es norma de Estanterías Jomasi S.L. **no servir ningún pedido** si existe alguno anterior pendiente de pago.
- Estanterías Jomasi S.L. se reserva la **plena propiedad de las mercancías** hasta que el cliente haya satisfecho totalmente el pago pactado.
- En caso de **controversia o litigio** ambas partes aceptan, con renuncia expresa al fuero propio del cliente, la competencia de los Tribunales de Zaragoza.

## GENERAL TERMS

- **Orders** are to be placed by e-mail.
- **Delivery times** are orientative. Estanterías Jomasi S.L. will not be responsible for delays in materials that are consequence of causes beyond their control nor will this be considered due reason for cancellation by the buyer, nor for any penalty by damages that third parties may attribute to the customer.
- All the **orders less than 200 €**, without counting transporting costs or assembly, will carry a surcharge of 25 €, in addition to the opening of the package, in case this occurs.
- If goods are sent **carriage paid**, Estanterías Jomasi S.L. reserves the right to contract the service of the transport agency of its preference. Transport terms establish that the transport is included until the door of the customer. And in no case transport includes unloading if sent by truck, nor placing it inside the customer's facilities if sent by local delivery agency.
- All the orders which **price is less than the agreed for prepaid shipping**, the amount in concept of postage will charge to the account, being the minimum 21 €.
- **The reshipment** to a new address will involve a cost of 12 € attributed to administration's costs.
- The opening of a package is considered "**special packaging**" and has a cost of 1,85 € net per package.
- The price of **the material assembled from the factory does not include unloading or placement in the customer's facilities**. If you are interested in these services, contact us.
- Receipt of visibly **faulty or erroneous material** must be recorded on the transport delivery note indicating damaged material or pending to review and then, within a maximum period of 24 hours, reported in writing to Estanterías Jomasi S.L. Otherwise material will be understood to have been received and accepted correctly and in a good state.
- If the customer decides to **return the goods**, and no later than 30 days from the purchase, Estanterías Jomasi S.L. reserves the right to pay the goods, applying a devaluation of 10% as well as the cost of the round trip transport.
- The **return of a payment** supposes an increase of 4% in the amount of the commercial invoice.
- It is Estanterías Jomasi S.L. policy **not to deliver an order** if there is a previous order that is unpaid.
- Estanterías Jomasi S.L. reserves its **full ownership of the goods** until the customer has paid the agreed amount.
- In case of **controversy or litigation**, both parties accept, with expressly waiving the client's own jurisdiction, the jurisdiction of the Courts of Zaragoza (Spain).

## CONDITIONS GENERALES

- Les **commandes** seront passées par e-mail.
- Les **délais de livraison** sont donnés à titre indicatif, Estanterías Jomasi ne sera responsable d'aucun retard des matériels ayant pour origine des causes indépendantes de sa volonté et ne constituera pas de motif d'annulation de la part de l'acheteur ni de pénalisation pour préjudices au client pouvant dériver de tiers.
- Les **commandes inférieures à 200€ net**, hors frais de transport et de montage, feront l'objet d'une majoration de 25 €, plus les frais d'ouverture du colis si nécessaire.
- Quand la marchandise est transportée à **ports payés** par Estanterías Jomasi, S.L., celle-ci se réserve le droit de choisir l'agence de transport qu'elle considérera la plus opportune. Le transport est entendu jusqu'à la porte du client et n'inclura en aucun cas, le déchargement quand la commande est envoyée par camion routier ni l'emplacement à l'intérieur des locaux du client lorsqu'il s'agira d'agence de distribution sur place.
- Les **commandes dont le montant est inférieur au montant convenu pour le port payé**, le montant du port sera facturé sur la facture, soit le minimum de 21 €.
- La **réexpédition** à un domicile autre que celui du client entraîne un coût de 12 € de gestion administrative.
- L'ouverture d'un paquet est considérée "**emballage spécial**" et a un cout de 1,85€/net par paquet.
- Le prix du **matériel assemblé à partir de l'usine ne comprend pas le déchargement ou la localisation chez le client**. Si vous avez besoin de ces services, veuillez nous contacter.
- A la réception visible de **matériel défectueux ou erroné** il devra être indiqué à la signature du bordereau de livraison et noter sous réserve de vérification, dans un délai maximum de 24 heures et par écrit à estanterías jomasi S.L., passez ce délais nous ne pouvons plus accepter les réclamations des dommages, il sera entendu que la marchandise acceptée est correcte et en bon état.
- En ce qui concerne le **retour de marchandise** our des raisons propres du client et dans un délai inférieur à 30 jours depuis la date d'achat de cette marchandise, Estanterías Jomasi, S.L., se réserve le droit de rembourser cette marchandise en appliquant une dépréciation de 10%, outre le coût dérivé du transport.
- Le **retour d'un paiement** implique une majoration de 4% du montant de la facture.
- Estanterías Jomasi S.L., a pour norme de **ne servir aucune commande** s'il en existe d'autres précédentes qui n'ont pas encore été réglées.
- Estanterías Jomasi, S.L. se réserve **la pleine propriété des marchandises** jusqu'à ce que le client ait satisfait totalement le prix accordé.
- En cas de **controverse ou litige** les deux partie-s acceptent, en renonçant expressément à la compétence propre du client, la compétence des tribunaux de Saragosse (Espagne).

# 8-17

Ángulo ranurado  
Slotted angle shelving  
Cornière perforée

Sistema de almacenaje muy versátil y económico.

A versatile and economical storage system option.

L'option la plus économique.



Con tornillos  
With bolts  
Avec vis



125kg  
Peso por balda  
Weight per shelf  
Poids par tablette

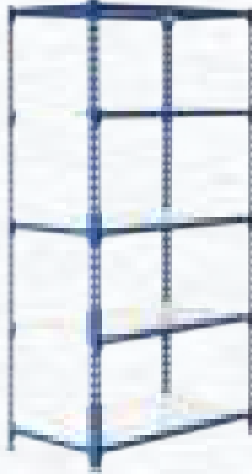

# 18-27

J200 Sistema de encastre  
J200 Socket system  
J200 Cornière clipsable

Estantería Metálica sin tornillos muy fácil de montar.

Metal shelving without screws very easy to assemble.

Etagère métallique montage très facile.



275kg  
Peso por balda  
Weight per shelf  
Poids par tablette



Sin tornillos  
Without bolts  
Sans vis



Martillo nylon  
Nylon hammer  
Marteau nylon

# 28-45

J600 Sistema de encastre  
J600 Socket system  
J600 Cornière clipsable

Ideal para talleres y almacenes

Ideal for workshops and warehouses.

Parfait pour magasin, atelier, entrepôt ou garage.



600kg  
Peso por balda  
Weight per shelf  
Poids par tablette



Sin tornillos  
Without bolts  
Sans vis



Martillo nylon  
Nylon hammer  
Marteau nylon



# 36-45

Bancos de trabajo  
Work benches  
Établissements de travail



# 46-51

Media Carga  
Heavy-Duty Racking  
Charges Mi-lourd

Estantería picking de gran capacidad diseñada para una carga de forma manual.

High capacity picking rack designed for a manual charge.

Rayonnage Picking haute capacité conçu pour une charge manuelle.



975kg  
Peso por balda  
Weight per shelf  
Poids par tablette

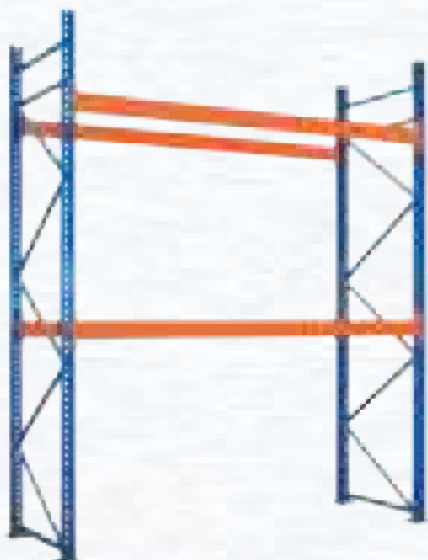

# 52-57

Paletización Convencional  
Pallet Racking  
Rack à palette

La solución más rentable y flexible para el almacenaje de productos paletizados.  
The most economical and flexible solution for the storage of palletized products.  
La solution la plus rentable et la plus flexible pour le stockage de produits palettisés.



## Legenda de símbolos / Symbol legend / Légende de symboles

**L** Longitud  
Length  
Longueur

**P** Profundidad  
Depth  
**D** Profondeur

**H** Altura  
Height  
Hauteur

**A** Ancho  
Width  
Largueur

Medidas mm / Measurements mm / Mesures mm  
Peso kg / Weight kg/ poids kg  
Volumen m3 / Volumen m3 / volume m3

# 58 - 71

Taquillas Metálicas  
Metal Lockers  
Casiers Métalliques

Armarios roperos, taquillas y consignas.  
Wardrobes and lockers.  
Armoires et casiers.



# 72-75

Bancos de Vestuario  
Locker Room Benches  
Bancs de Vestiaire

Bancos para vestuario sencillos, dobles, con repisa y perchas.  
Benches for single and double changing rooms, with shelves and coat racks.  
Bancs pour vestiaires simples et doubles, avec étagères et porte-manteaux..

# 76 - 86

Serie Venecia  
Venice Series  
Série Venise

Armarios metálicos de ordenación y limpieza.  
Metal storage and cleaning cabinets.  
Armoires de rangement et de nettoyage en métal.



# Ángulo ranurado / Slotted angle shelving / Rayonnage à visser

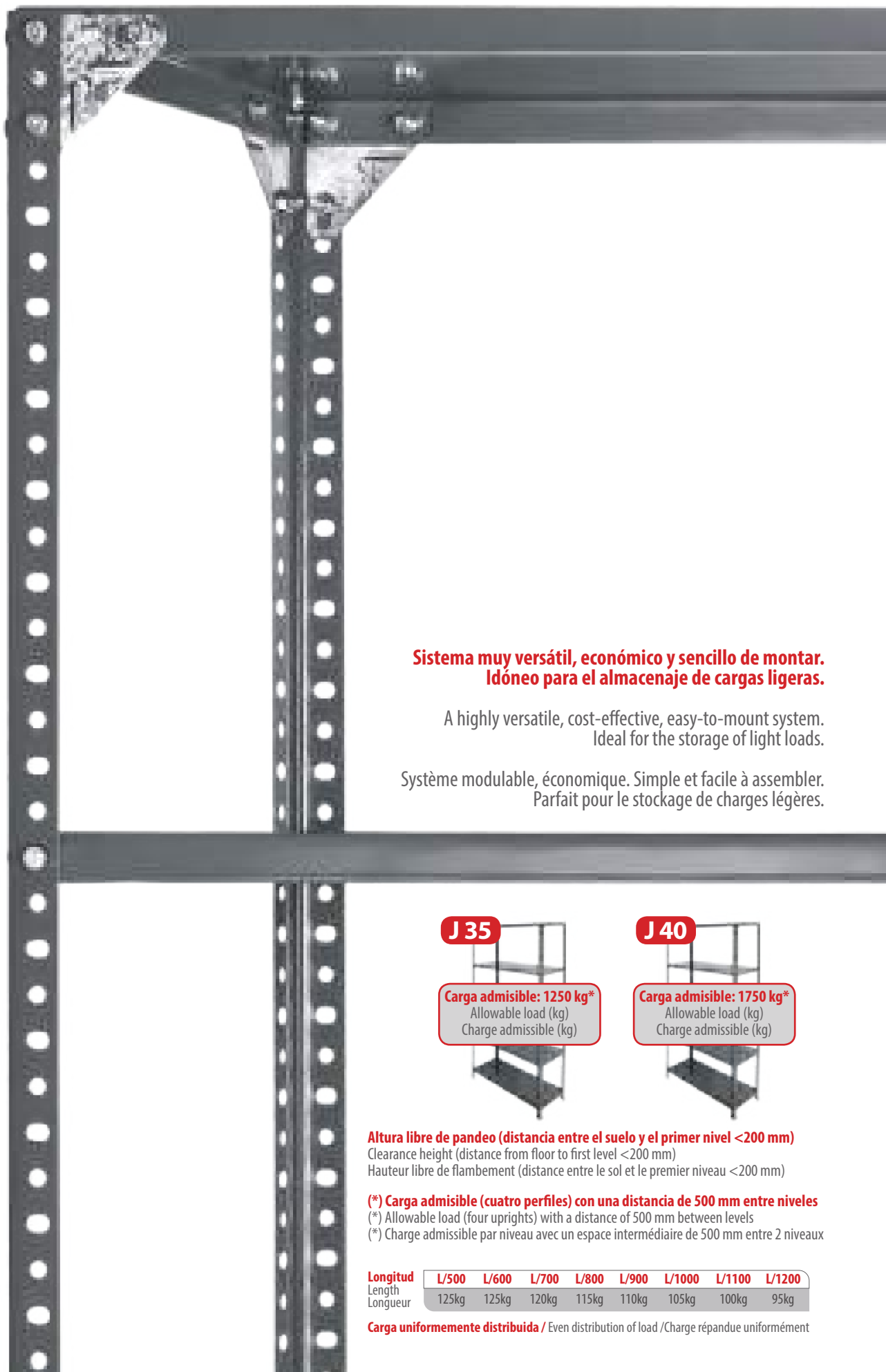

**Sistema muy versátil, económico y sencillo de montar. Idóneo para el almacenaje de cargas ligeras.**

A highly versatile, cost-effective, easy-to-mount system. Ideal for the storage of light loads.

Système modulable, économique. Simple et facile à assembler. Parfait pour le stockage de charges légères.

**J 35**

**Carga admisible: 1250 kg\***  
Allowable load (kg)  
Charge admissible (kg)



**J 40**

**Carga admisible: 1750 kg\***  
Allowable load (kg)  
Charge admissible (kg)



**Altura libre de pandeo (distancia entre el suelo y el primer nivel <200 mm)**  
Clearance height (distance from floor to first level <200 mm)  
Hauteur libre de flambement (distance entre le sol et le premier niveau <200 mm)

**(\*) Carga admisible (cuatro perfiles) con una distancia de 500 mm entre niveles**  
(\* Allowable load (four uprights) with a distance of 500 mm between levels  
(\* Charge admissible par niveau avec un espace intermédiaire de 500 mm entre 2 niveaux

Longitud Length Longueur	L/500	L/600	L/700	L/800	L/900	L/1000	L/1100	L/1200
	125kg	125kg	120kg	115kg	110kg	105kg	100kg	95kg

**Carga uniformemente distribuida / Even distribution of load / Charge répartie uniformément**





**Perfil** / Upright / Montant



**Balda** / Shelf / Tablette



**Tornillo** / Bolt / Vis



**Escuadra**  
Corner piece  
Équerre

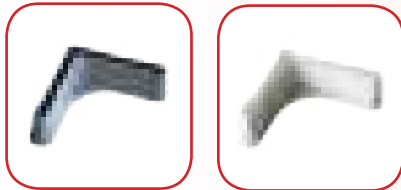

**Base de plástico**  
Plastic foot  
Pied plastique

**Contenedor delantero**  
Front band  
Traverses avant conteneur



**Contenedor trasero**  
Back band  
Traverse arrière conteneur



**Divisor de contenedor**  
Band divider  
Séparateur de conteneur



**Divisor de pestaña**  
Wall divider  
Séparateur onglet



**Cajón** / Bin / Tiroir

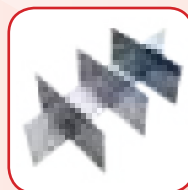

**Divisor cajón**  
Bin divider  
Séparateur tiroir



**Refuerzo balda**  
Shelf stiffeners  
Renfort tablette



**Chapa lateral**  
Side plate / Tôle latérale

**Chapa frontal**  
Front plate / Tôle frontale



# Ángulo ranurado / Slotted angle shelving / Rayonnage à visser

J/35

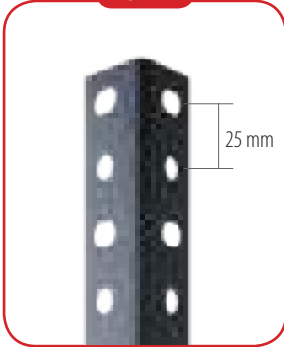

J/40

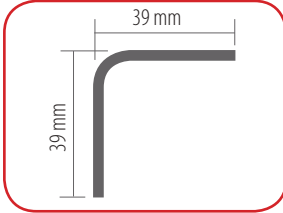
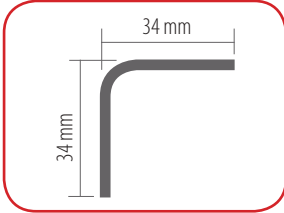
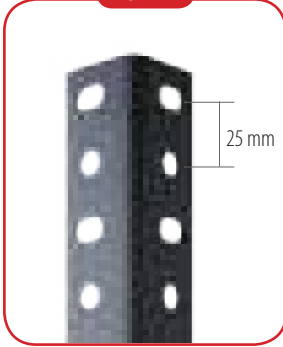

## Perfiles / Uprights / Montants

Artículo L Item L Article L	Referencia Reference Référence	€/ Unidad €/ Unit €/ Unité	Cod. EAN EAN Code Code EAN	Peso kg Weight kg Poids kg	Uds. paquete Units package Unités par paquet
J/35 de 2000	99013520	6,84	8431206135203	1,41	10
J/35 de 2500	99013525	8,55	8431206135258	1,76	10
J/35 de 3000	99013530	10,26	8431206135302	2,11	10

RAL 7046 Gris / Grey / Gris

## Perfiles / Uprights / Montants

Artículo L Item L Article L	Referencia Reference Référence	€/ Unidad €/ Unit €/ Unité	Cod. EAN EAN Code Code EAN	Peso kg Weight kg Poids kg	Uds. paquete Units package Unités par paquet
J/40 de 2000	99014020	8,88	8431206140207	1,76	10
J/40 de 2500	99014025	11,10	8431206140252	2,20	10
J/40 de 3000	99014030	13,32	8431206140306	2,64	10

RAL 7046 Gris / Grey / Gris

Corte a medida perfil: 0,35 €/neto / Upright cut-to size: 0.35 €/net / Coupe sur mesure profilé: 0,35 €/net

## Baldas / Shelves / Tablettes

Artículo LxP Item LxD Article LxP	Referencia Reference Référence	€/ Unidad €/ Unit €/ Unité	Cod. EAN EAN Code Code EAN	Peso kg Weight kg Poids kg	Uds. paquete Units package Unités par paquet
500 x 300	99010503	8,56	8431206105039	1,23	6
500 x 400	99010504	9,71	8431206105046	1,54	6
600 x 300	99010603	9,32	8431206106036	1,45	6
600 x 400	99010604	10,67	8431206106043	1,81	6
600 x 500	99010605	13,29	8431206106050	2,48	6
600 x 600	99010606	14,94	8431206106067	2,90	6
700 x 300	99010703	10,07	8431206107033	1,67	6
700 x 400	99010704	11,62	8431206107040	2,09	6
700 x 500	99010705	14,68	8431206107057	2,86	6
700 x 600	99010706	16,52	8431206107064	3,33	6
800 x 300	99010803	10,85	8431206108030	1,90	6
800 x 400	99010804	12,59	8431206108047	2,36	6
800 x 500	99010805	16,08	8431206108054	3,24	6
800 x 600	99010806	18,16	8431206108061	3,77	6
800 x 700	99010807	20,24	8431206108078	4,31	6
900 x 300	99010903	11,59	8431206109037	2,12	6
900 x 400	99010904	13,55	8431206109044	2,64	6
900 x 500	99010905	17,49	8431206109051	3,61	6
900 x 600	99010906	19,79	8431206109068	4,21	6
900 x 700	99010907	22,07	8431206109075	4,81	6
1000 x 300	99011003	12,33	8431206110033	2,34	6
1000 x 400	99011004	14,52	8431206110040	2,91	6
1000 x 500	99011005	18,91	8431206110057	3,99	6
1000 x 600	99011006	21,40	8431206110064	4,65	6
1000 x 700	99011007	23,90	8431206110071	5,31	6

RAL 7046 Gris / Grey / Gris

## Base sencilla / Single foot / Pied plastique

Artículo Item Article	Referencia Reference Référence	€/ Envase €/ Pack €/ Emballage	Cod. EAN EAN Code Code EAN	Peso kg Weight kg Poids kg	Unidades envase Units packs Unités par emballage
Base sencilla 35 Gris / Single foot Grey / Pied plastique Gris	99010011	3,68	8431206100119	0,04	Blister 4 / Blister pack / Blister
Base sencilla 40 Gris / Single foot Grey / Pied plastique Gris	99010013	3,68	8431206100133	0,04	Blister 4 / Blister pack / Blister
Base sencilla 35 Gris / Single foot Grey / Pied plastique Gris	99010015	20,24	8431206100157	0,65	Caja 100 / Box / Boîte
Base sencilla 40 Gris / Single foot Grey / Pied plastique Gris	99010017	20,24	8431206100171	0,67	Caja 100 / Box / Boîte
Base sencilla 35 Gris / Single foot Grey / Pied plastique Gris	99010019	265,65	---	9,75	Saco 1500 / Bag / Sac
Base sencilla 40 Gris / Single foot Grey / Pied plastique Gris	99010021	265,65	---	10,09	Saco 1500 / Bag / Sac

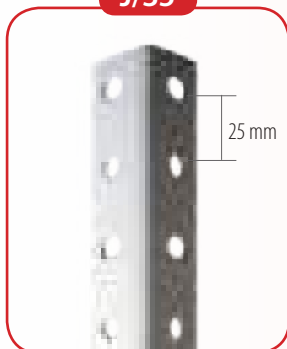
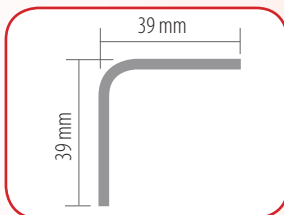
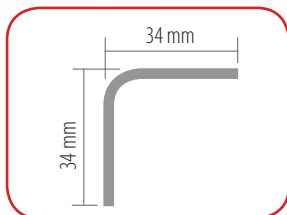
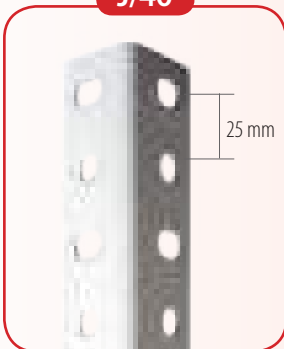
**J/35****J/40**

## Perfiles / Uprights / Montants

Artículo L Item L Article L	Referencia Reference Référence	€/Unidad €/Unit €/Unité	Cod. EAN EAN Code Code EAN	Peso kg Weight kg Poids kg	Uds. paquete Units package Unités par paquet
J/35 de 2000	99023520	7,12	8431206235200	1,41	10
J/35 de 2500	99023525	8,90	8431206235255	1,76	10
J/35 de 3000	99023530	10,68	8431206235309	2,11	10

RAL 9003 Blanco / White / Blanc

## Perfiles / Uprights / Montants

Artículo L Item L Article L	Referencia Reference Référence	€/Unidad €/Unit €/Unité	Cod. EAN EAN Code Code EAN	Peso kg Weight kg Poids kg	Uds. paquete Units package Unités par paquet
J/40 de 2000	99024020	9,24	8431206240204	1,76	10
J/40 de 2500	99024025	11,55	8431206240259	2,20	10
J/40 de 3000	99024030	13,86	8431206240303	2,64	10

RAL 9003 Blanco / White / Blanc

Corte a medida perfil: 0,35 €/neto / Upright cut-to size: 0.35 €/net / Coupe sur mesure profilé: 0,35 €/net



## Baldas / Shelves / Tablettes

Artículo LxP Item LxD Article LxP	Referencia Reference Référence	€/Unidad €/Unit €/Unité	Cod. EAN EAN Code Code EAN	Peso kg Weight kg Poids kg	Uds. paquete Units package Unités par paquet
600 x 300	99020603	9,69	8431206206033	1,45	6
600 x 400	99020604	11,10	8431206206040	1,81	6
600 x 500	99020605	13,82	8431206206057	2,48	6
600 x 600	99020606	15,54	8431206206064	2,90	6
700 x 300	99020703	10,47	8431206207030	1,67	6
700 x 400	99020704	12,08	8431206207047	2,09	6
700 x 500	99020705	15,27	8431206207054	2,86	6
700 x 600	99020706	17,18	8431206207061	3,33	6
800 x 300	99020803	11,28	8431206208037	1,90	6
800 x 400	99020804	13,09	8431206208044	2,36	6
800 x 500	99020805	16,72	8431206208051	3,24	6
800 x 600	99020806	18,89	8431206208068	3,77	6
900 x 300	99020903	12,05	8431206209034	2,12	6
900 x 400	99020904	14,09	8431206209041	2,64	6
900 x 500	99020905	18,19	8431206209058	3,61	6
900 x 600	99020906	20,58	8431206209065	4,21	6
1000 x 300	99021003	12,82	8431206210030	2,34	6
1000 x 400	99021004	15,10	8431206210047	2,91	6
1000 x 500	99021005	19,67	8431206210054	3,99	6
1000 x 600	99021006	22,26	8431206210061	4,65	6

RAL 9003 Blanco / White / Blanc

## Base sencilla / Single foot / Pied plastique

Artículo Item Article	Referencia Reference Référence	€/Envase €/Pack €/Emballage	Cod. EAN EAN Code Code EAN	Peso kg Weight kg Poids kg	Uds. envase Units packs Unités par emballage
Base sencilla 35 Blanca / Single foot White / Pied plastique Blanc	99010012	3,68	8431206100126	0,04	Blister 4 / Blister pack / Blister
Base sencilla 40 Blanca / Single foot White / Pied plastique Blanc	99010014	3,68	8431206100140	0,04	Blister 4 / Blister pack / Blister
Base sencilla 35 Blanca / Single foot White / Pied plastique Blanc	99010016	20,24	8431206100164	0,65	Caja 100 / Box / Boîte
Base sencilla 40 Blanca / Single foot White / Pied plastique Blanc	99010018	20,24	8431206100188	0,67	Caja 100 / Box / Boîte

# Ángulo ranurado / Slotted angle shelving / Rayonnage à visser

J/35

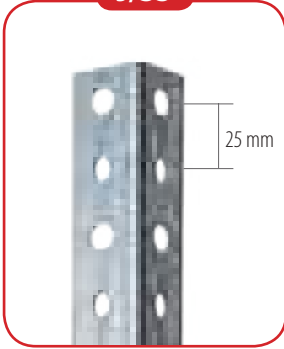

J/40

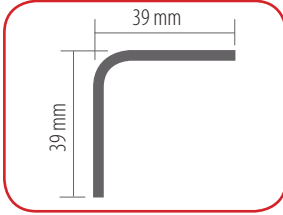
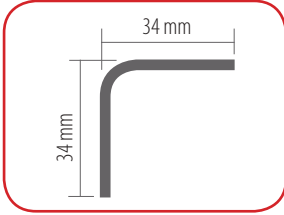
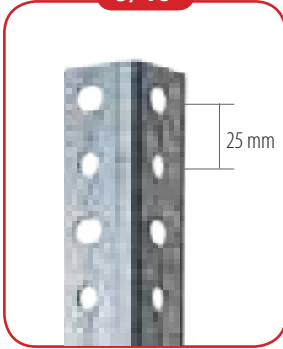

## Perfiles / Uprights / Montants

Artículo L Item L Article L	Referencia Reference Référence	€/Unidad €/Unit €/Unité	Cod. EAN EAN Code Code EAN	Peso kg Weight kg Poids kg	Uds. paquete Units package Unités par paquet
J/35 de 2000	99093520	8,24	8431206935209	1,41	10
J/35 de 2500	99093525	10,30	8431206935254	1,76	10
J/35 de 3000	99093530	12,36	8431206935308	2,11	10

Galvanizado / galvanized / galvanisée

## Perfiles / Uprights / Montants

Artículo L Item L Article L	Referencia Reference Référence	€/Unidad €/Unit €/Unité	Cod. EAN EAN Code Code EAN	Peso kg Weight kg Poids kg	Uds. paquete Units package Unités par paquet
J/40 de 2000	99094020	10,80	8431206940203	1,76	10
J/40 de 2500	99094025	13,50	8431206940258	2,20	10
J/40 de 3000	99094030	16,20	8431206940302	2,64	10

Galvanizado / galvanized / galvanisée

Corte a medida perfil: 0,35 €/neto / Upright cut-to size: 0.35 €/net / Coupe sur mesure profilé: 0,35 €/net

## Baldas / Shelves / Tablettes

Artículo LxP Item LxD Article LxP	Referencia Reference Référence	€/Unidad €/Unit €/Unité	Cod. EAN EAN Code Code EAN	Peso kg Weight kg Poids kg	Uds. paquete Units package Unités paquet
500 x 300	99090503	8,67	8431206905035	1,23	6
500 x 400	99090504	9,74	8431206905042	1,54	6
600 x 300	99090603	9,41	8431206906032	1,45	6
600 x 400	99090604	10,71	8431206906049	1,81	6
600 x 500	99090605	13,73	8431206906056	2,48	6
600 x 600	99090606	15,44	8431206906063	2,90	6
700 x 300	99090703	10,16	8431206907039	1,67	6
700 x 400	99090704	11,68	8431206907046	2,09	6
700 x 500	99090705	15,27	8431206907053	2,86	6
700 x 600	99090706	17,12	8431206907060	3,33	6
800 x 300	99090803	10,90	8431206908036	1,90	6
800 x 400	99090804	12,66	8431206908043	2,36	6
800 x 500	99090805	16,64	8431206908050	3,24	6
800 x 600	99090806	18,79	8431206908067	3,77	6
900 x 300	99090903	11,67	8431206909033	2,12	6
900 x 400	99090904	13,64	8431206909040	2,64	6
900 x 500	99090905	18,10	8431206909057	3,61	6
900 x 600	99090906	20,47	8431206909064	4,21	6
1000 x 300	99091003	12,42	8431206910039	2,34	6
1000 x 400	99091004	14,60	8431206910046	2,91	6
1000 x 500	99091005	19,57	8431206910053	3,99	6
1000 x 600	99091006	22,15	8431206910060	4,65	6
1100 x 300	99091103	16,01	8431206911036	2,92	6
1100 x 400	99091104	18,97	8431206911043	3,65	6
1100 x 500	99091105	22,66	8431206911050	4,37	6
1100 x 600	99091106	25,70	8431206911067	5,09	6
1200 x 300	99091203	17,08	8431206912033	3,17	6
1200 x 400	99091204	20,25	8431206912040	3,96	6
1200 x 500	99091205	24,22	8431206912057	4,75	6
1200 x 600	99091206	27,50	8431206912064	5,53	6

Galvanizado / galvanized / galvanisée





## Tornillos / Bolts / Boulons

Artículo Item Article	Referencia Reference Référence	€/Envase €/Pack €/Emballage	Cod. EAN EAN Code Code EAN	Peso kg Weight kg Poids kg	Uds. envase Units pack Unités de l'emballage
Tornillo M8 x 16 ZC M8 x 16 ZC Bolt Boulon M8 x 16 ZC	99010001	8,05	8431206100010	0,59	Blister 40 40 Blister pack Blister 40
Tornillo M8 x 16 ZC M8 x 16 ZC Bolt Boulon M8 x 16 ZC	99010003	30,36	8431206100034	2,95	Caja 200 200 Box Boîte 200



## Escuadra galvanizada / Galvanized corner piece / Équerre galvanisée

Artículo Item Article	Referencia Reference Référence	€/Envase €/Pack €/Emballage	Cod. EAN EAN Code Code EAN	Peso kg Weight kg Poids kg	Uds. envase Units pack Unités par emballage
Escuadra galvanizada Galvanized corner piece Équerre galvanisée	99090006	6,00	8431206900061	0,20	Blister 8 8 Blister pack Blister 8
Escuadra galvanizada Galvanized corner piece Équerre galvanisée	99090007	33,93	8431206900078	2,70	Caja 100 100 Box Boîte 100
Escuadra galvanizada Galvanized corner piece Équerre galvanisée	99090009	370,09	---	30,00	Saco 1200 1200 Bag Sac 1200

Galvanizado / galvanized / galvanisée



## Escuadra blanca / White corner piece / Équerre blanc

Artículo Item Article	Referencia Reference Référence	€/Envase €/Pack €/Emballage	Cod. EAN EAN Code Code EAN	Peso kg Weight kg Poids kg	Uds. envase Units pack Unités de l'emballage
Escuadra blanca White corner piece Équerre blanc	99020006	6,23	8431206200062	0,20	Blister 8 8 Blister pack Blister 8
Escuadra blanca White corner piece Équerre blanc	99020007	35,28	8431206200079	2,70	Caja 100 100 Box Boîte 100

RAL 9003 Blanco / White / Blanc

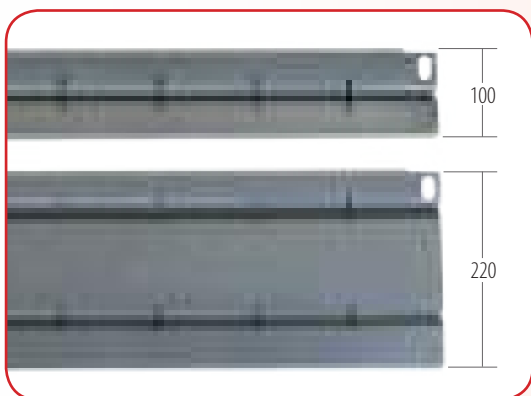

## Contenedores / Bands / Conteneur

Artículo Item Article	Referencia Reference Référence	€/Unidad €/Unit €/Unité	Cod. EAN EAN Code Code EAN	Peso kg Weight kg Poids kg	Uds. paquete Units package Unités par paquet
Delantero 600 / Front / Avant	99010042	9,16	8431206100423	0,43	10
Delantero 700 / Front / Avant	90010043	9,56	8431206100430	0,50	10
Delantero 800 / Front / Avant	99010044	9,96	8431206100447	0,57	10
Delantero 900 / Front / Avant	99010045	10,36	8431206100454	0,65	10
Delantero 1000 / Front / Avant	99010046	10,76	8431206100461	0,72	10
Trasero 600 / Back / Arrière	99010052	10,95	8431206100522	0,80	10
Trasero 700 / Back / Arrière	90010053	11,74	8431206100539	0,94	10
Trasero 800 / Back / Arrière	99010054	12,53	8431206100546	1,08	10
Trasero 900 / Back / Arrière	99010055	13,32	8431206100553	1,21	10
Trasero 1000 / Back / Arrière	99010056	14,11	8431206100560	1,35	10

RAL 7046 Gris / Grey / Gris



# Ángulo ranurado / Slotted angle shelving / Rayonnage à visser

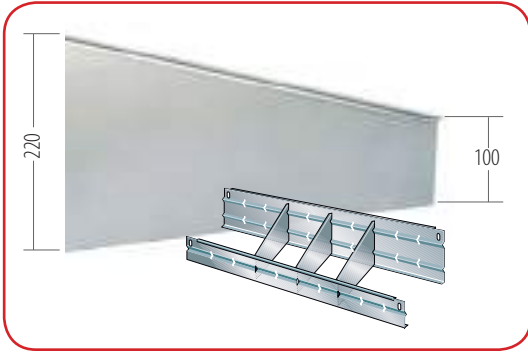

## Divisores de contenedor / Band dividers / Séparateurs de conteneur

Artículo Item Article	Referencia Reference Référence	€/Unidad €/Unit €/Unité	Cod. EAN EAN Code Code EAN	Peso kg Weight kg Poids kg	Uds. paquete Units package Unités par paquet
Divisor 300 / Divider / Séparateur	99090063	5,64	8431206900634	0,27	20
Divisor 400 / Divider / Séparateur	99090064	5,95	8431206900641	0,36	20
Divisor 500 / Divider / Séparateur	99090065	6,26	8431206900658	0,45	20
Divisor 600 / Divider / Séparateur	99090066	6,57	8431206900665	0,54	20

Galvanizado / galvanized / galvanisée 

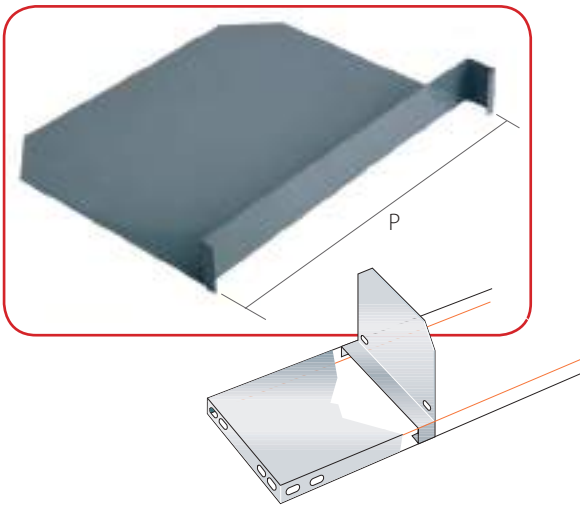

## Divisores de pestaña / Wall dividers / Séparateurs d'onglet

Artículo PxH Item PxH Article PxH	Referencia Reference Référence	€/Unidad €/Unit €/Unité	Cod. EAN EAN Code Code EAN	Peso kg Weight kg Poids kg	Uds. paquete Units package Unités par paquet
Divisor 300 x 250H Divider / Séparateur	99010073	11,09	8431206100737	0,57	1
Divisor 400 x 250H Divider / Séparateur	99010074	11,57	8431206100744	0,75	1
Divisor 500 x 250H Divider / Séparateur	99010075	12,05	8431206100751	0,93	1
Divisor 600 x 250H Divider / Séparateur	99010076	12,53	8431206100768	1,11	1

RAL 7046 Gris / Grey / Gris 

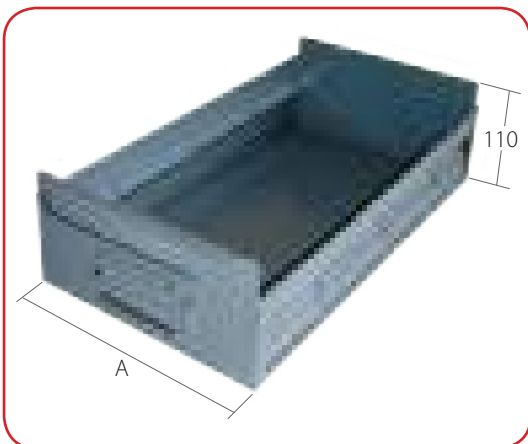

## Cajones / Bins / Tiroirs

Artículo PxA Item PxA Article PxA	Referencia Reference Référence	€/Unidad €/Unit €/Unité	Cod. EAN EAN Code Code EAN	Peso kg Weight kg Poids kg	Uds. paquete Units package Unités par paquet
C/300 x 200	99010083	12,83	8431206100836	0,87	8
C/300 x 270	99010084	14,36	8431206100843	1,06	6
C/400 x 200	99010085	14,95	8431206100850	1,10	8
C/400 x 270	99010086	16,74	8431206100867	1,32	6
C/500 x 200	99010087	17,40	8431206100874	1,32	8
C/500 x 270	99010088	19,48	8431206100881	1,58	6

RAL 7046 Gris / Grey / Gris 

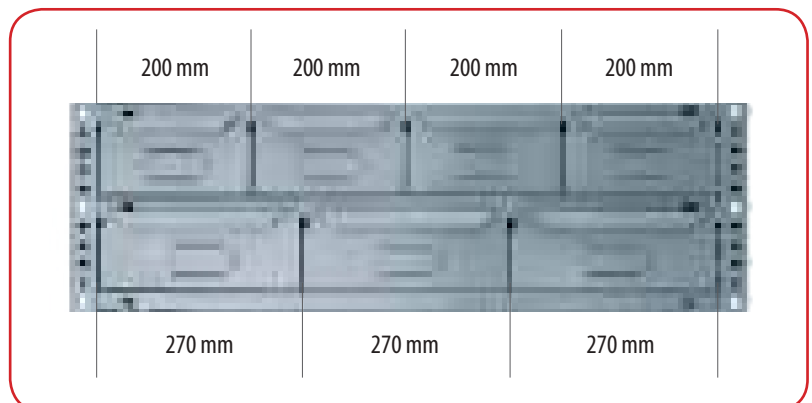
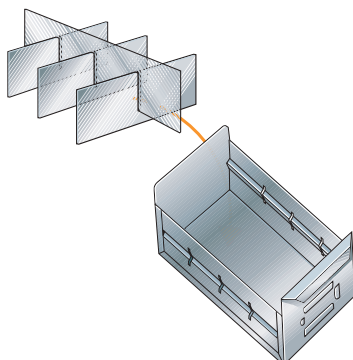

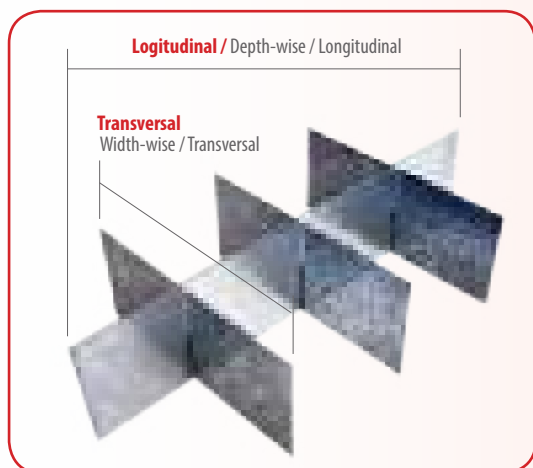

## Divisores de cajón / Bin dividers / Séparateurs tiroir

Artículo L Item L Article L	Referencia Reference Référence	€/Unidad €/Unit €/Unité	Cod. EAN EAN Code Code EAN	Peso kg Weight kg Poids kg	Uds. paquete Units package Unités par paquet
Transversal 200 Width-wise / Transversal	99090091	2,01	8431206900917	0,08	---
Transversal 270 Width-wise / Transversal	99090092	2,07	8431206900924	0,11	---
Longitudinal 300 Depth-wise / Longitudinal	99090093	2,29	8431206900931	0,11	---
Longitudinal 400 Depth-wise / Longitudinal	99090094	2,36	8431206900948	0,15	---
Longitudinal 500 Depth-wise / Longitudinal	99090095	2,43	8431206900955	0,19	---

Galvanizado / galvanized / galvanisée

## Refuerzos para baldas / Shelf stiffeners / Renforts tablettes

Artículo L Item L Article L	Referencia Reference Référence	€/Unidad €/Unit €/Unité	Cod. EAN EAN Code Code EAN	Peso kg Weight kg Poids kg	Uds. paquete Units package Unités par paquet
R. Soldado/ 800 Welded stiffener / R.Soudé	99010104	5,15	---	---	---
R. Soldado 900 Welded stiffener / R.Soudé	99010105	5,36	---	---	---
R. Soldado 1000 Welded stiffener / R.Soudé	99010106	5,57	---	---	---
R. Atornillado 600 Bolted stiffener / R.Vissé	99010112	4,35	8431206101123	0,35	10
R. Atornillado 700 Bolted stiffener / R.Vissé	99010113	4,63	8431206101130	0,41	10
R. Atornillado 800 Bolted stiffener / R.Vissé	99010114	4,91	8431206101147	0,47	10
R. Atornillado 900 Bolted stiffener / R.Vissé	99010115	5,19	8431206101154	0,53	10
R. Atornillado 1000 Bolted stiffener / R.Vissé	99010116	5,47	8431206101161	0,59	10

RAL 7046 Gris / Grey / Gris



## Chapas laterales y frontales

Side and front plates / Tôles latérales et avant

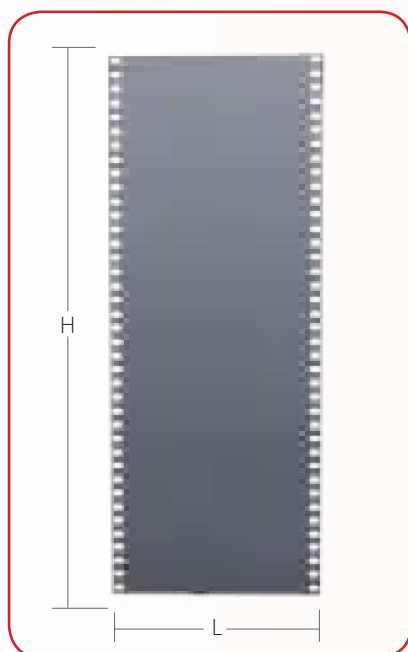

Artículo LxH Item LxH Article LxH	Referencia Reference Référence	€/Unidad €/Unit €/Unité	Cod. EAN EAN Code Code EAN	Peso kg Weight kg Poids kg	Uds. paquete Units package Unités par paquet
Chapa 300 x 1000H Plate / Tôle	99010123	13,30	8431206101239	1,34	1
Chapa 400 x 1000H Plate / Tôle	99010124	15,60	8431206101246	1,80	1
Chapa 500 x 1000H Plate / Tôle	99010125	17,90	8431206101253	2,26	1
Chapa 600 x 1000H Plate / Tôle	99010126	20,20	8431206101260	2,72	1
Chapa 700 x 1000H Plate / Tôle	99010127	22,50	8431206101277	3,16	1
Chapa 800 x 1000H Plate / Tôle	99010128	24,80	8431206101284	3,62	1
Chapa 900 x 1000H Plate / Tôle	99010129	27,10	8431206101291	4,08	1
Chapa 1000 x 1000H Plate / Tôle	99010130	29,40	8431206101307	4,54	1

RAL 7046 Gris / Grey / Gris

# Ángulo ranurado / Slotted angle shelving / Rayonnage à visser

## Kits Almacén



  
**RAL 9003 Blanco**  
White  
Blanc



  
**RAL 7046 Gris**  
Grey  
Gris





**Con tornillos**  
With bolts  
Avec vis







**Peso por balda**  
Weight per shelf  
Poids par tablette



**Unidades**  
Units / Unités

	<b>8</b> 900 mm
	<b>4</b>
	<b>5</b> 900 x 300 mm
	<b>40</b>

**Unidades**  
Units / Unités

	<b>8</b> 900 mm
	<b>4</b>
	<b>5</b> 900 x 400 mm
	<b>40</b>

**Unidades**  
Units / Unités

	<b>8</b> 900 mm
	<b>4</b>
	<b>5</b> 900 x 300 mm
	<b>40</b>

**Unidades**  
Units / Unités

	<b>8</b> 900 mm
	<b>4</b>
	<b>5</b> 900 x 400 mm
	<b>40</b>

### Almacén 5.30

Artículo Item Article	Referencia Reference Référence	€/Unidad €/Unit €/Unité	Cod. EAN EAN Code Code EAN	Peso kg Weight kg Poids kg	Uds. paquete Units package Unités par paquet	Dim. packaging Dim. packaging Dim. d'emballage	Unidades palé Pallet units Unités par palettes
Almacén 5.30	98017830	76,59	8431206178309	14,37	1	900H x 320W x 105D	40

RAL 9003 Blanco / White / Blanc



Tiempo de montaje  
Assembly time  
Temps de d'assemblage

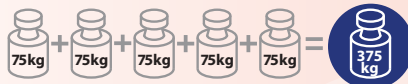

### Almacén 5.40

Artículo Item Article	Referencia Reference Référence	€/Unidad €/Unit €/Unité	Cod. EAN EAN Code Code EAN	Peso kg Weight kg Poids kg	Uds. paquete Units package Unités par paquet	Dim. packaging Dim. packaging Dim. d'emballage	Unidades palé Pallet units Unités par palettes
Almacén 5.40	98017840	87,80	8431206178408	16,61	1	900H x 420W x 105D	26

RAL 9003 Blanco / White / Blanc



Tiempo de montaje  
Assembly time  
Temps de d'assemblage

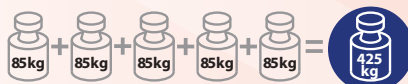

### Almacén 5.30

Artículo Item Article	Referencia Reference Référence	€/Unidad €/Unit €/Unité	Cod. EAN EAN Code Code EAN	Peso kg Weight kg Poids kg	Uds. paquete Units package Unités par paquet	Dim. packaging Dim. packaging Dim. d'emballage	Unidades palé Pallet units Unités par palettes
Almacén 5.30	98017930	73,65	8431206179306	14,37	1	900H x 320W x 105D	40

RAL 7046 Gris / Grey / Gris



Tiempo de montaje  
Assembly time  
Temps de d'assemblage

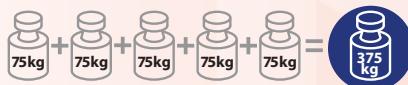

### Almacén 5.40

Artículo Item Article	Referencia Reference Référence	€/Unidad €/Unit €/Unité	Cod. EAN EAN Code Code EAN	Peso kg Weight kg Poids kg	Uds. paquete Units package Unités par paquet	Dim. packaging Dim. packaging Dim. d'emballage	Unidades palé Pallet units Unités par palettes
Almacén 5.40	98017940	84,43	8431206179405	16,61	1	900Hx 420W x 105W	26

RAL 7046 Gris / Grey / Gris



Tiempo de montaje  
Assembly time  
Temps de d'assemblage

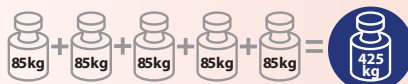

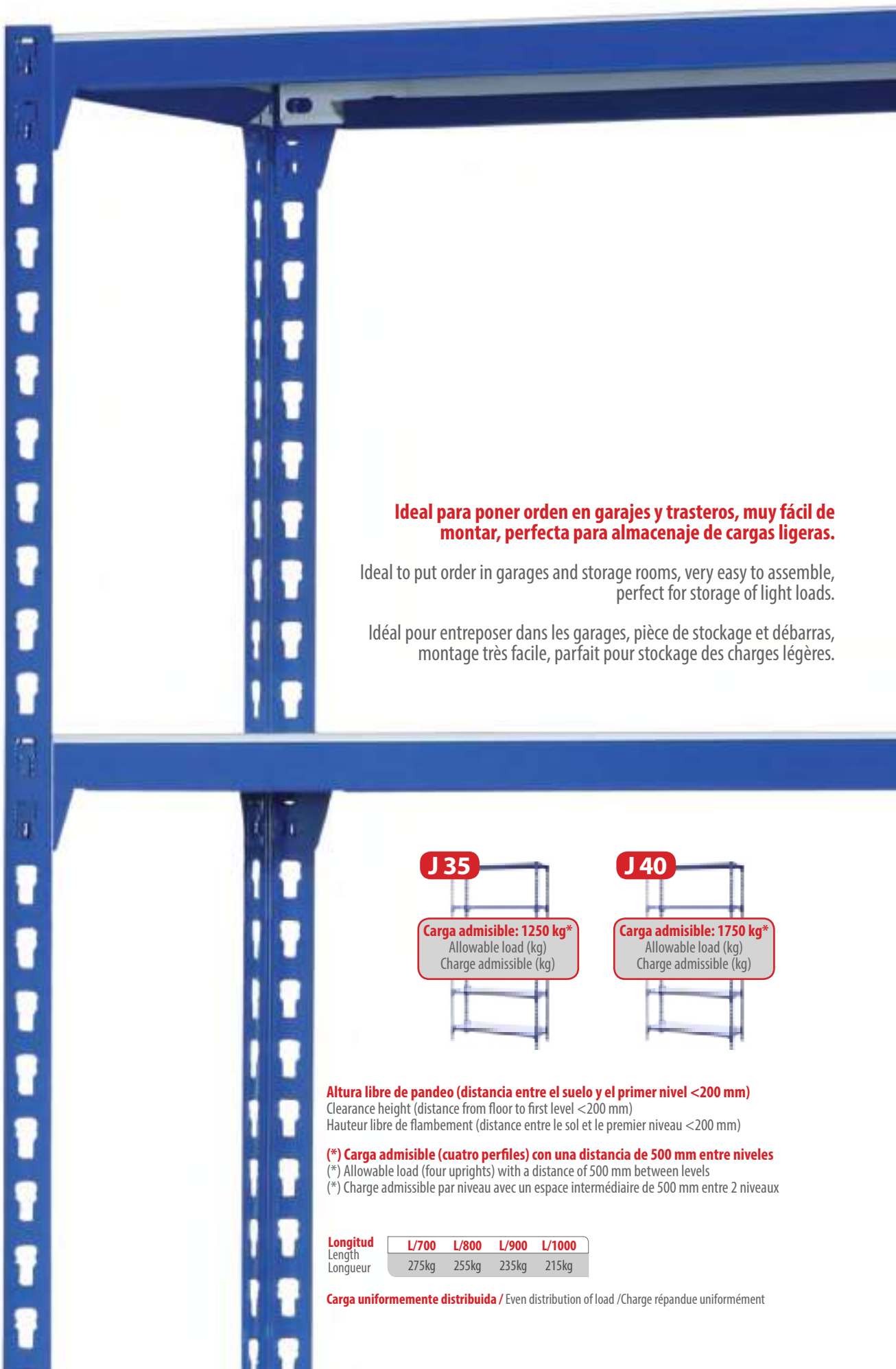

**Ideal para poner orden en garajes y trasteros, muy fácil de montar, perfecta para almacenaje de cargas ligeras.**

Ideal to put order in garages and storage rooms, very easy to assemble, perfect for storage of light loads.

Idéal pour entreposer dans les garages, pièce de stockage et débarras, montage très facile, parfait pour stockage des charges légères.

**J 35**

**Carga admisible: 1250 kg\***  
Allowable load (kg)  
Charge admissible (kg)



**J 40**

**Carga admisible: 1750 kg\***  
Allowable load (kg)  
Charge admissible (kg)



**Altura libre de pandeo (distancia entre el suelo y el primer nivel <200 mm)**

Clearance height (distance from floor to first level <200 mm)

Hauteur libre de flambement (distance entre le sol et le premier niveau <200 mm)

**(\*) Carga admisible (cuatro perfiles) con una distancia de 500 mm entre niveles**

(\*) Allowable load (four uprights) with a distance of 500 mm between levels

(\*) Charge admissible par niveau avec un espace intermédiaire de 500 mm entre 2 niveaux

Longitud Length Longueur	L/700	L/800	L/900	L/1000
	275kg	255kg	235kg	215kg

**Carga uniformemente distribuida / Even distribution of load / Charge répartue uniformément**

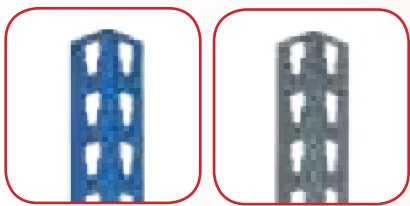

Perfil / Upright / Montant



Larguero V / V Beam / Lisse et traverse

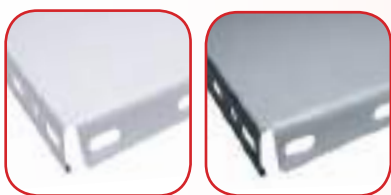

Balda / Shelf / Tablette



Aglomerado / Chipboard / Aggloméré



Base de plástico / Plastic foot / Pied plastique



(\* Carga uniformemente distribuida  
Even distribution of load / Charge répartie uniformément

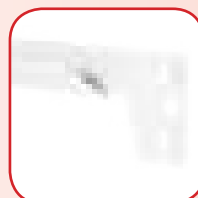

# J200 sistema de encastre / socket system / système d'assemblage

J/35

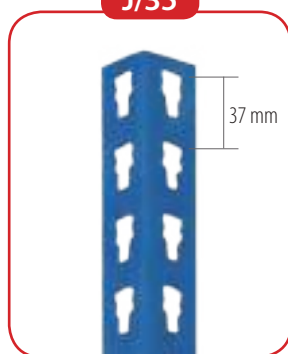

J/40

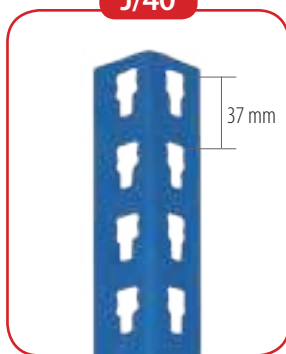

## Perfiles / Uprights / Montants

Artículo L Item L Article L	Ref. Azul Ref. Blue Réf. Bleu	€/Unidad €/Unit €/Unité	Cod. EAN EAN Code Code EAN	Peso kg Weight kg Poids kg	Uds. Paquete Units Package Unités par paquet
J/35 de 888	73033509	2,76	8431206731054	0,66	10
J/35 de 999	73033510	3,10	8431296731061	0,74	10
J/35 de 1998	73033520	6,20	8431206731108	1,48	10
J/35 de 2479	73033525	7,69	8431206731139	1,84	10
J/35 de 2997	73033530	9,30	8431206731153	2,22	10

RAL 5010 Azul / Blue / Bleu



## Perfiles / Uprights / Montants

Artículo L Item L Article L	Ref. Azul Ref. Blue Réf. Bleu	€/Unidad €/Unit €/Unité	Código EAN EAN Code Code EAN	Peso kg Weight kg Poids kg	Uds. Paquete Units Package Unités par paquet
J/40 de 1998	75034020	7,20	8431206751106	1,83	10
J/40 de 2479	75034025	8,93	8431206751137	2,27	10
J/40 de 2997	75034030	10,80	8431206751151	2,75	10

RAL 5010 Azul / Blue / Bleu

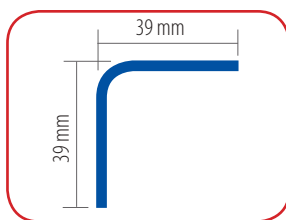
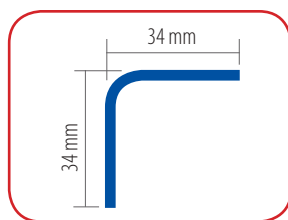

## Largueros "V" / "V" Beams / Lisses et traverses "V"

Artículo L Item L Article L	Ref. Azul Ref. Blue Réf. Bleu	€/Unidad €/Unit €/Unité	Código EAN EAN Code Code EAN	Peso kg Weight kg Poids kg	Uds. Paquete Units Package Unités par paquet
300	73032030	1,39	8431206732037	0,23	10
400	73032040	1,70	8431206732044	0,30	10
500	73032050	2,01	8431206732051	0,37	10
600	73032060	2,32	8431206732068	0,44	10
700	73032070	2,63	8431206732075	0,51	10
800	73032080	2,94	8431206732082	0,58	10
900	73032090	3,25	8431206732099	0,65	10
1000	73032100	3,56	8431206732105	0,72	10

RAL 5010 Azul / Blue / Bleu

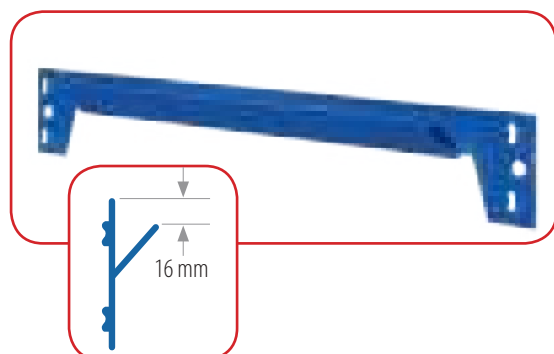

## Largueros "V" / "V" Beams / Lisses et traverses "V"

Artículo L Item L Article L	Ref. Naranja Ref. Orange Réf. Orange	€/Unidad €/Unit €/Unité	Código EAN EAN Code Code EAN	Peso kg Weight kg Poids kg	Uds. Paquete Units Package Unités par paquet
300	73042030	1,55	8431206732433	0,23	10
400	73042040	1,86	8431206732440	0,30	10
500	73042050	2,17	8431206732457	0,37	10
600	73042060	2,48	8431206732464	0,44	10
700	73042070	2,79	8431206732471	0,51	10
800	73042080	3,10	8431206732488	0,58	10
900	73042090	3,41	8431206732495	0,65	10
1000	73042100	3,72	8431206732501	0,72	10

RAL 2004 Naranja / Orange / Orange

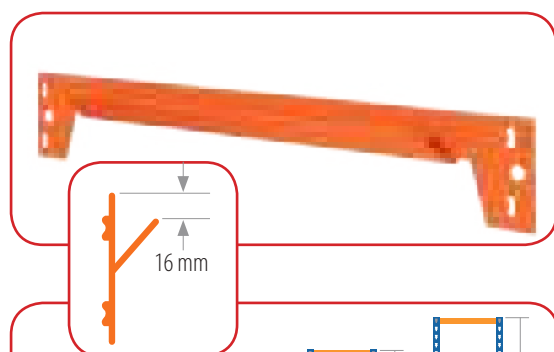

Número mínimo de largueros por altura

Minimum number of beams by height.

Nombre minimum de lisses par hauteur.

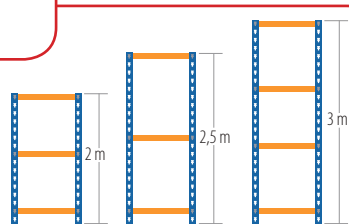

### J 35

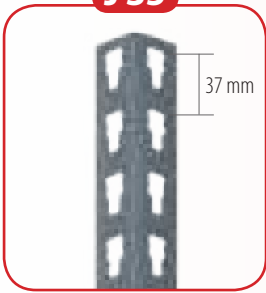

### J 40

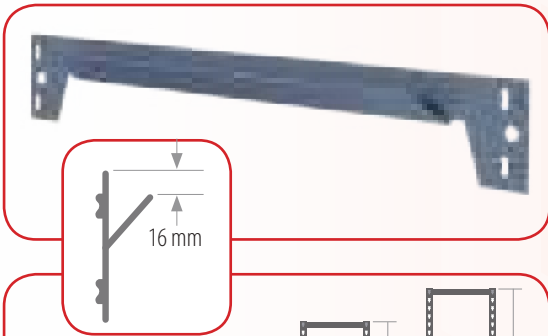
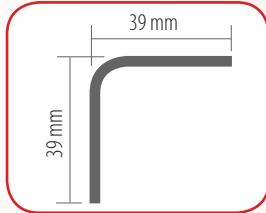
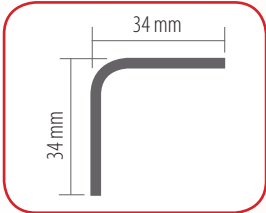
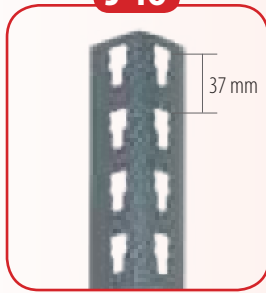

#### Número mínimo de largueros por altura

Minimum number of beams by height.

Minimum Barre transversale par hauteur.

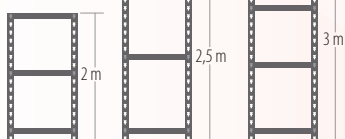

Espesor / Thickness / Épaisseur

## Perfiles / Uprights / Montants

Artículo L Item L Article L	Ref. Gris Ref. Grey Réf. Gris	€/Unidad €/Unit €/Unité	Cod. EAN EAN Code Code EAN	Peso kg Weight kg Poids kg	Uds. Paquete Units Package Unités par paquet
J/35 de 888	73013509	2,76	8431206731252	0,66	10
J/35 de 999	73013510	3,10	8431296731269	0,74	10
J/35 de 1998	73013520	6,20	8431206731306	1,48	10
J/35 de 2479	73013525	7,69	8431206731337	1,84	10
J/35 de 2997	73013530	9,30	8431206731351	2,22	10

RAL 7046 Gris / Grey / Gris

## Perfiles / Uprights / Montants

Artículo L Item L Article L	Ref. Gris Ref. Grey Réf. Gris	€/Unidad €/Unit €/Unité	Cod. EAN EAN Code Code EAN	Peso kg Weight kg Poids kg	Uds. Paquete Units Package Unités par paquet
J/40 de 1998	75014020	7,20	8431206751304	1,83	10
J/40 de 2479	75014025	8,93	8431206751335	2,27	10
J/40 de 2997	75014030	10,80	8431206751359	2,75	10

RAL 7046 Gris / Grey / Gris

## Largueros "V" / "V" Beams / Lisses et traverses "V"

Artículo L Item L Article L	Ref. Gris Ref. Grey Réf. Gris	€/Unidad €/Unit €/Unité	Cod. EAN EAN Code Code EAN	Peso kg Weight kg Poids kg	Uds. Paquete Units Package Unités par paquet
300	73012030	1,39	8431206732235	0,23	10
400	73012040	1,70	8431206732242	0,30	10
500	73012050	2,01	8431206732259	0,37	10
600	73012060	2,32	8431206732266	0,44	10
700	73012070	2,63	8431206732273	0,51	10
800	73012080	2,94	8431206732280	0,58	10
900	73012090	3,25	8431206732297	0,65	10
1000	73012100	3,56	8431206732303	0,72	10

RAL 7046 Gris / Grey / Gris

## Aglomerado / Chipboard / Aggloméré

Artículo LxP Item LxD Article LxP	Referencia Reference Référence	€/Unidad €/Unit €/Unité	Cod. EAN EAN Code Code EAN	Peso kg Weight kg Poids kg	Uds. Paquete Units Package Unités par paquet
690 x 300	73070030	4,51	8431206739111	2,12	1
690 x 400	73070040	5,98	8431206739128	2,83	1
690 x 500	73070050	7,71	8431206739135	3,53	1
690 x 600	73070060	8,96	8431206739142	4,24	1
790 x 300	73080030	5,37	8431206739210	2,43	1
790 x 400	73080040	7,28	8431206739227	3,24	1
790 x 500	73080050	9,49	8431206739234	4,04	1
790 x 600	73080060	11,18	8431206739241	4,85	1
890 x 300	73090030	5,81	8431206739319	2,73	1
890 x 400	73090040	7,76	8431206739326	3,65	1
890 x 500	73090050	9,96	8431206739333	4,56	1
890 x 600	73090060	11,61	8431206739340	5,47	1
990 x 300	73100030	6,76	8431206739418	3,04	1
990 x 400	73100040	8,96	8431206739425	4,06	1
990 x 500	73100050	11,57	8431206739432	5,07	1
990 x 600	73100060	13,47	8431206739449	6,08	1

# J200 sistema de encastre / socket system / système d'assemblage

J/35

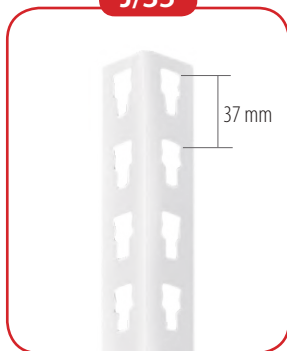

J/40

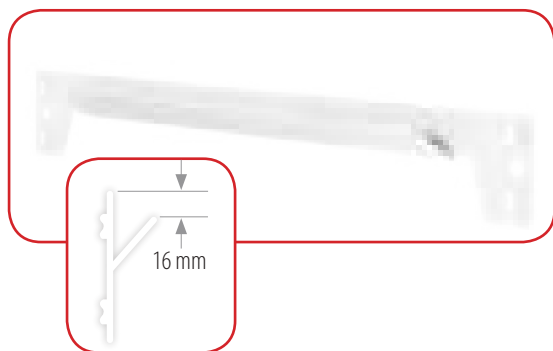
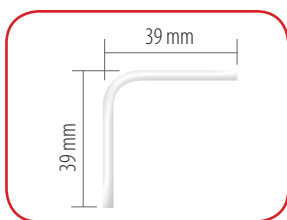
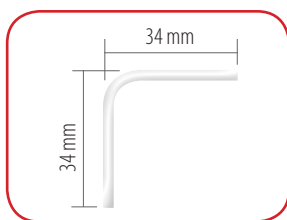
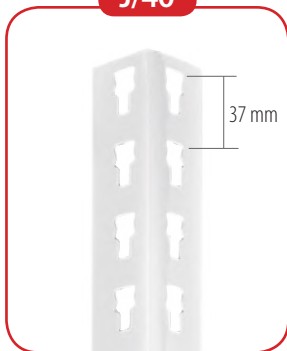

## Perfiles / Uprights / Montants

Artículo L Item L Article L	Ref. Azul Ref. Blue Réf. Bleu	€/Unidad €/Unit €/Unité	Cod. EAN EAN Code Code EAN	Peso kg Weight kg Poids kg	Uds. Paquete Units Package Unités par paquet
J/35 de 888	73023509	2,87	8431206731658	0,66	10
J/35 de 999	73023510	3,22	8431206731665	0,74	10
J/35 de 1998	73023520	6,45	8431206731702	1,48	10
J/35 de 2479	73023525	8,00	8431206731733	1,84	10
J/35 de 2997	73023530	9,67	8431206731757	2,22	10

RAL 9003 Blanco / Blue / Bleu

## Perfiles / Uprights / Montants

Artículo L Item L Article L	Ref. Azul Ref. Blue Réf. Bleu	€/Unidad €/Unit €/Unité	Código EAN EAN Code Code EAN	Peso kg Weight kg Poids kg	Uds. Paquete Units Package Unités par paquet
J/40 de 1998	75024020	7,50	8431206751700	1,83	10
J/40 de 2479	75024025	9,30	8431206751731	2,27	10
J/40 de 2997	75024030	11,25	8431206751755	2,75	10

RAL 9003 Blanco / Blue / Bleu

## Largueros "V" / "V" Beams / Lisses et traverses "V"

Artículo L Item L Article L	Ref. Azul Ref. Blue Réf. Bleu	€/Unidad €/Unit €/Unité	Código EAN EAN Code Code EAN	Peso kg Weight kg Poids kg	Uds. Paquete Units Package Unités par paquet
300	73022030	1,44	8431206732631	0,23	10
400	73022040	1,75	8431206732648	0,30	10
500	73022050	2,06	8431206732655	0,37	10
600	73022060	2,37	8431206732662	0,44	10
700	73022070	2,68	8431206732679	0,51	10
800	73022080	2,99	8431206732686	0,58	10
900	73022090	3,30	8431206732693	0,65	10
1000	73022100	3,61	8431206732709	0,72	10

RAL 9003 Blanco / Blue / Bleu

## Accesorios / accessories / accessoires

Artículo L Item L Article L	Referencia Reference Référence	€/Unidad €/Unit €/Unité	Código EAN EAN Code Code EAN	Peso kg Weight kg Poids kg	Uds. Paquete Units Package Unités par paquet
Pletina 1,5 mm. 1.5 mm L. plate P. de calage 1,5 mm.	73000008	0,75	8431206730088	0,02	4
Pie Metálico Metal foot Pied métallique	73000031	1,30	8431206730316	0,04	4
Unión Perfil - Gris Bracket union - Grey Union Profilé - Gris	73000032	1,00	8431206730323	0,09	4
Unión Perfil - Azul Bracket union - Blue Union Profilé - Bleu	73000033	1,00	8431206730330	0,09	4
Unión Perfil - Blanco Bracket union - White Union Profilé - Blanc	73000034	1,04	8431206730347	0,09	4
Anclaje M6x60/suelo M6x60 Anchor/floor Ancrage M6x60/sol	73000035	0,52	8431206730354	0,01	4



Pie metálico\*  
Metal foot  
Pied métallique



Pletina  
Levelling plate  
Plaque de calage



Anclaje  
Anchors  
Ancrages



\*Tornillos Incluidos  
Screws included  
Vis incluses **2uds.**



Unión perfil  
Upright attachment  
Union montant

### Baldas / Shelves / Tablettes



Artículo LxP Item LxD Article LxP	Referencia Reference Référence	€/ Unidad €/ Unit €/ Unité	Cod. EAN EAN Code Code EAN	Peso kg Weight kg Poids kg	Uds. paquete Units package Unités par paquet
700 x 300	99020703	-	8431206207030	1,67	6
700 x 400	99020704	-	8431206207047	2,09	6
700 x 500	99020705	-	8431206207054	2,86	6
700 x 600	99020706	-	8431206207061	3,33	6
800 x 300	99020803	-	8431206208037	1,90	6
800 x 400	99020804	-	8431206208044	2,36	6
800 x 500	99020805	-	8431206208051	3,24	6
800 x 600	99020806	-	8431206208068	3,77	6
900 x 300	99020903	-	8431206209034	2,12	6
900 x 400	99020904	-	8431206209041	2,64	6
900 x 500	99020905	-	8431206209058	3,61	6
900 x 600	99020906	-	8431206209065	4,21	6
1000 x 300	99021003	-	8431206210030	2,34	6
1000 x 400	99021004	-	8431206210047	2,91	6
1000 x 500	99021005	-	8431206210054	3,99	6
1000 x 600	99021006	-	8431206210061	4,65	6

RAL 9003 Blanco / White / Blanc



### Baldas / Shelves / Tablettes

Artículo LxP Item LxD Article LxP	Referencia Reference Référence	€/ Unidad €/ Unit €/ Unité	Cod. EAN EAN Code Code EAN	Peso kg Weight kg Poids kg	Uds. paquete Units package Unités par paquet
700 x 300	99010703	-	8431206107033	1,67	6
700 x 400	99010704	-	8431206107040	2,09	6
700 x 500	99010705	-	8431206107057	2,86	6
700 x 600	99010706	-	8431206107064	3,33	6
800 x 300	99010803	-	8431206108030	1,90	6
800 x 400	99010804	-	8431206108047	2,36	6
800 x 500	99010805	-	8431206108054	3,24	6
800 x 600	99010806	-	8431206108061	3,77	6
900 x 300	99010903	-	8431206109037	2,12	6
900 x 400	99010904	-	8431206109044	2,64	6
900 x 500	99010905	-	8431206109051	3,61	6
900 x 600	99010906	-	8431206109068	4,21	6
1000 x 300	99011003	-	8431206110033	2,34	6
1000 x 400	99011004	-	8431206110040	2,91	6
1000 x 500	99011005	-	8431206110057	3,99	6
1000 x 600	99011006	-	8431206110064	4,65	6

RAL 7046 Gris / Grey / Gris

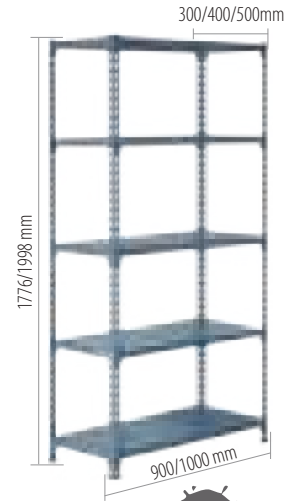

**RAL 7046 Gris**  
Grey  
Gris

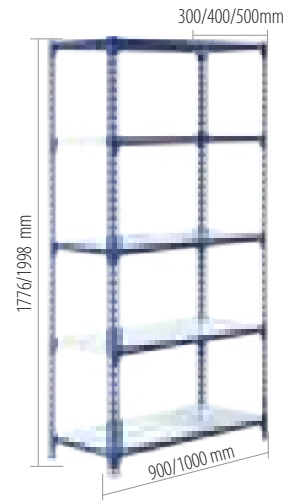

**RAL 5010 Azul** Blue  
Bleu  
**RAL 9003 Blanco** White  
Blanc

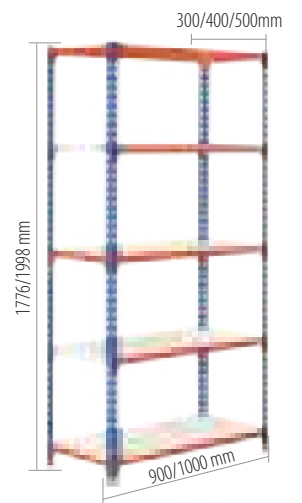

**RAL 5010 Azul** Blue  
Bleu  
**RAL 2004 Naranja** Orange  
Orange  
**RAL 9003 Blanco** White  
Blanc



**Sin tornillos**  
Without bolts  
Sans vis



**Martillo nylon**  
Nylon hammer  
Marteau nylon



**Tiempo de montaje**  
Assembly time  
Temps de assemblage







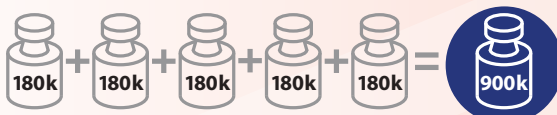

**J200 5 niveles /** J200 5 levels / J200 5 niveaux

Unidades Units / Unités	
	<b>8</b> 888 / 999 mm
	<b>4</b>
	<b>6</b> 300/400/500 mm
	<b>10</b> 900/1000 mm
	<b>5</b> 900 x 300 mm 900 x 400 mm 900 x 500 mm 1000 x 300 mm 1000 x 400 mm 1000 x 500 mm

Artículo Item Article	Ref. Gris Ref. Grey Réf. Gris	€/Unidad €/Unit €/Unité	Cod. EAN EAN Code Code EAN	Peso kg Weight kg Poids kg	Uds. paquete Units package Unités par paquet	Dim. packaging Dim. de l'emballage	Unidades palé Pallet units Unités par palettes
J200.1800.900.300.5B	731110935	104,04	8431206735137	23,76	1	900H x 315W x 105D	25
J200.1800.900.400.5B	731110945	112,79	8431206735144	26,78	1	900H x 415W x 105D	19
J200.1800.900.500.5B	731110955	128,45	8431206735151	32,05	1	900H x 515W x 105D	14
J200.2000.1000.300.5B	731111035	112,44	8431206735175	26,20	1	1000H x 315W x 105D	25
J200.2000.1000.400.5B	731111045	121,97	8431206735182	29,47	1	1000H x 415W x 105D	19
J200.2000.1000.500.5B	731111055	139,21	8431206735199	35,29	1	1000H x 515W x 105D	14

RAL 7046 Gris / Grey / Gris





**J200 5 niveles /** J200 5 levels / J200 5 niveaux

Unidades Units / Unités	
	<b>8</b> 888 / 999 mm
	<b>4</b>
	<b>6</b> 300/400/500 mm
	<b>10</b> 900/1000 mm
	<b>5</b> 900 x 300 mm 900 x 400 mm 900 x 500 mm 1000 x 300 mm 1000 x 400 mm 1000 x 500 mm

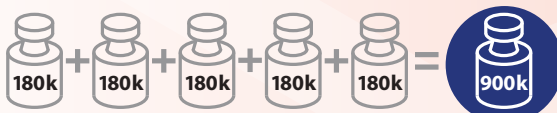
Artículo Item Article	Ref. Azul / Blanco Ref. Blue / White Réf. Bleu / Blanc	€/Unidad €/Unit €/Unité	Cod. EAN EAN Code Code EAN	Peso kg Weight kg Poids kg	Uds. paquete Units package Unités par paquet	Dim. packaging Dim. de l'emballage	Unidades palé Pallet units Unités par palettes
J200.1800.900.300.5B	733320935	105,63	8431206735038	23,76	1	900H x 315W x 105D	25
J200.1800.900.400.5B	733320945	114,69	8431206735045	26,78	1	900H x 415W x 105D	19
J200.1800.900.500.5B	733320955	130,84	8431206735052	32,05	1	900H x 515W x 105D	14
J200.2000.1000.300.5B	733321035	114,14	8431206735076	26,20	1	1000H x 315W x 105D	25
J200.2000.1000.400.5B	733321045	123,99	8431206735083	29,47	1	1000H x 415W x 105D	19
J200.2000.1000.500.5B	733321055	141,87	8431206735090	35,29	1	1000H x 515W x 105D	14

RAL 5010 Azul / Blue / Bleu RAL 9003 Blanco / White / Blanc

**J200 5 niveles /** J200 5 levels / J200 5 niveaux

Unidades Units / Unités	
	<b>8</b> 888 / 999 mm
	<b>4</b>
	<b>6</b> 300/400/500 mm
	<b>10</b> 900/1000 mm
	<b>5</b> 900 x 300 mm 900 x 400 mm 900 x 500 mm 1000 x 300 mm 1000 x 400 mm 1000 x 500 mm

Artículo Item Article	Ref. Azul / Naranja / Blanco Ref. Blue / Orange / White Réf. Bleu / Orange / Blanc	€/Unidad €/Unit €/Unité	Cod. EAN EAN Code Code EAN	Peso kg Weight kg Poids kg	Uds. paquete Units package Unités par paquet	Dim. packaging Dim. de l'emballage	Unidades palé Pallet units Unités par palettes
J200.1800.900.300.5B	733420935	108,21	8431206735236	23,76	1	900H x 315W x 105D	25
J200.1800.900.400.5B	733420945	117,26	8431206735243	26,78	1	900H x 415W x 105D	19
J200.1800.900.500.5B	733420955	133,38	8431206735250	32,05	1	900H x 515W x 105D	14
J200.2000.1000.300.5B	733421035	116,72	8431206735274	26,20	1	1000H x 315W x 105D	25
J200.2000.1000.400.5B	733421045	126,56	8431206735281	29,47	1	1000H x 415W x 105D	19
J200.2000.1000.500.5B	733421055	144,42	8431206735298	35,29	1	1000H x 515W x 105D	14

RAL 5010 Azul / Blue / Bleu RAL 2004 Naranja / Orange / Orange RAL 9003 Blanco / White / Blanc

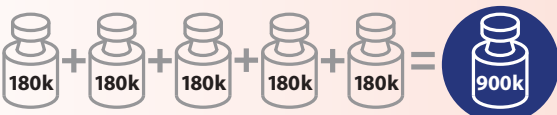



**Espesor / Thickness / Épaisseur**

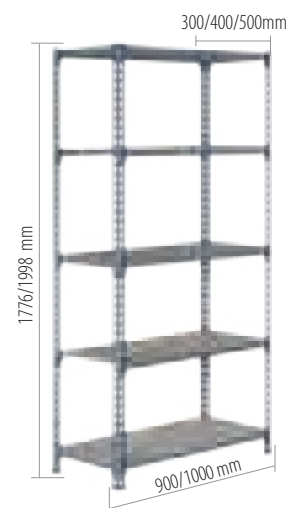

**RAL 7046 Gris**  
Grey  
Gris

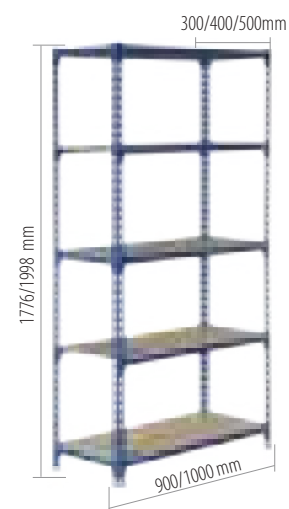

**RAL 5010 Azul**  
Blue  
Bleu

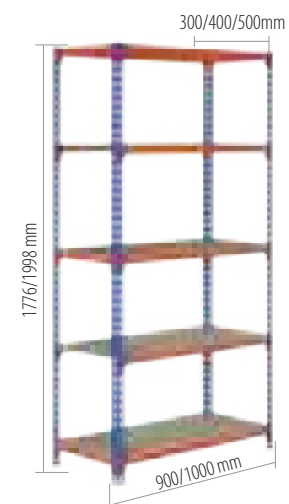

**RAL 5010 Azul** **RAL 2004 Naranja**  
Blue Orange  
Bleu Orange



**Sin tornillos**  
Without bolts  
Sans vis



**Martillo nylon**  
Nylon hammer  
Marteau nylon



**Tiempo de montaje**  
Assembly time  
Temps de d'assemblage

## J200 5 niveles / J200 5 levels / J200 5 niveaux



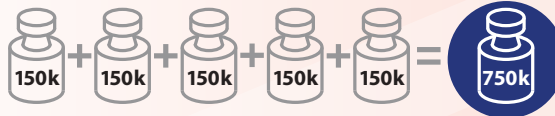

Unidades Units / Unités	
	<b>8</b> 888 / 999 mm
	<b>4</b>
	<b>6</b> 300/400/500 mm
	<b>10</b> 900/1000 mm
	<b>5</b> 890 x 300 mm 890 x 400 mm 890 x 500 mm 990 x 300 mm 990 x 400 mm 990 x 500 mm

Artículo Item Article	Ref. Gris Ref. Grey Réf. Gris	€/Unidad €/Unité	Cod. EAN EAN Code Code EAN	Peso kg Weight kg Poids kg	Uds. paquete Units package Unités par paquet	Dim. packaging Dim. de l'emballage	Unidades palé Pallet units Unités par palettes
J200.1800.900.300.5A	731100935	79,97	8431206736134	23,71	1	900H x 310W x 95D	27
J200/1800.900.400.5A	731100945	87,39	8431206736141	27,68	1	900H x 410W x 95D	21
J200.1800.900.500.5A	731100955	94,82	8431206736158	31,60	1	900H x 510W x 95D	14
J200.2000.1000.300.5A	731101035	87,74	8431206736172	26,25	1	1000H x 310W x 95D	27
J200.2000.1000.400.5A	731101045	95,46	8431206736189	30,62	1	1000H x 410W x 95D	21
J200.2000.1000.500.5A	731101055	103,79	8431206736196	34,94	1	1000H x 510W x 95D	14

RAL 7046 Gris / Grey / Gris



## J200 5 niveles / J200 5 levels / J200 5 niveaux





Unidades Units / Unités	
	<b>8</b> 888 / 999 mm
	<b>4</b>
	<b>6</b> 300/400/500 mm
	<b>10</b> 900/1000 mm
	<b>5</b> 890 x 300 mm 890 x 400 mm 890 x 500 mm 990 x 300 mm 990 x 400 mm 990 x 500 mm

Artículo Item Article	Ref. Azul Ref. Blue Réf. Bleu	€/Unidad €/Unité	Cod. EAN EAN Code Code EAN	Peso kg Weight kg Poids kg	Uds. paquete Units package Unités par paquet	Dim. packaging Dim. de l'emballage	Unidades palé Pallet units Unités par palettes
J200.1800.900.300.5A	733300935	79,97	8431206736035	23,71	1	900H x 310W x 95D	27
J200/1800.900.400.5A	733300945	87,39	8431206736042	27,68	1	900H x 410W x 95D	21
J200.1800.900.500.5A	733300955	94,82	8431206736059	31,60	1	900H x 510W x 95D	14
J200.2000.1000.300.5A	733301035	87,74	8431206736073	26,25	1	1000H x 310W x 95D	27
J200.2000.1000.400.5A	733301045	95,46	8431206736080	30,62	1	1000H x 410W x 95D	21
J200.2000.1000.500.5A	733301055	103,79	8431206736097	34,94	1	1000H x 510W x 95D	14

RAL 5010 Azul / Blue / Bleu



## J200 5 niveles / J200 5 levels / J200 5 niveaux

Unidades Units / Unités	
	<b>8</b> 888 / 999 mm
	<b>4</b>
	<b>6</b> 300/400/500 mm
	<b>10</b> 900/1000 mm
	<b>5</b> 890 x 300 mm 890 x 400 mm 890 x 500 mm 990 x 300 mm 990 x 400 mm 990 x 500 mm

Artículo Item Article	Ref. Azul / Naranja Ref. Blue / Orange Réf. Bleu / Orange	€/Unidad €/Unité	Cod. EAN EAN Code Code EAN	Peso kg Weight kg Poids kg	Uds. paquete Units package Unités par paquet	Dim. packaging Dim. de l'emballage	Unidades palé Pallet units Unités par palette
J200.1800.900.300.5A	733400935	82,54	8431206736233	23,71	1	900H x 310W x 95D	27
J200/1800.900.400.5A	733400945	89,97	8431206736240	27,68	1	900H x 410W x 95D	21
J200.1800.900.500.5A	733400955	97,36	8431206736257	31,60	1	900H x 510W x 95D	14
J200.2000.1000.300.5A	733401035	90,31	8431206736271	26,25	1	1000H x 310W x 95D	27
J200.2000.1000.400.5A	733401045	98,04	8431206736288	30,62	1	1000H x 410W x 95D	21
J200.2000.1000.500.5A	733401055	106,33	8431206736295	34,94	1	1000H x 510W x 95D	14

RAL 5010 Azul / Blue / Bleu RAL 2004 Naranja / Orange / Orange

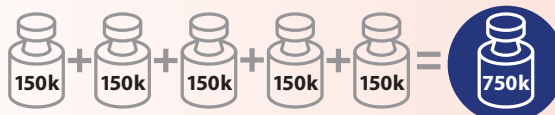

**J 40**



**Carga admisible: 1750 kg\***  
 Allowable load (kg)  
 Charge admissible (kg)

**Altura libre de pandeo**  
 (distancia entre el suelo y el primer nivel <200 mm)

Clearance height  
 (distance from floor to first level <200 mm)  
 Hauteur libre de flambement  
 (distance entre le sol et le premier niveau <200 mm)

**(\*) Carga admisible (cuatro perfiles)**  
 con una distancia de 500 mm entre niveles

(\*) Allowable load (four uprights)  
 with a distance of 500 mm between levels  
 (\*) Charge admissible (quatre montants)  
 avec une distance de 500 mm entre les niveaux

Larguero Beam Longueron	L/900	L/1200	L/1500	L/1800	L/2100	L/2400
	500 kg	500 kg	500 kg	500 kg	350 kg	350 kg

**Carga uniformemente distribuida**  
 Even distribution of load / Charge répartie uniformément

Perfil / Upright / Montant



P.11

Fondo "L"  
"L" Cross beam / Lisse

Base sencilla 40  
Single foot / Pied pastique

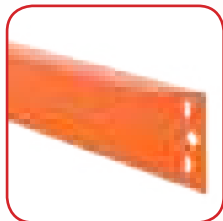

Larguero "C"  
"C" Beam / Traverse C

Aglomerado  
Chipboard  
Aggloméré



Travesaño de refuerzo  
Deck support / Barre de renfort

Balda galvanizada  
Galvanised shelf  
Tablette galvanisée



Accesorios / accessories / accessoires



Artículo L Item L Article L	Referencia Reference Référence	€/Unidad €/Unit €/Unité	Código EAN EAN Code Code EAN	Peso k Weight k Poids k	Uds. Paquete Units Package Unités par paquet
Pletina 1,5 mm. 1.5 mm L. plate P. de calage 1,5 mm.	73000008	0,75	8431206730088	0,02	4
Pie Metálico Metal foot Pied métallique	73000031	1,30	8431206730316	0,04	4
Unión Perfil - Azul Bracket union - Blue Union Profilé - Bleu	73000033	1,00	8431206730330	0,09	4
Anclaje M6x60/suelo M6x60 Anchor/floor Ancrage M6x60/sol	73000035	0,52	8431206730354	0,01	4
Retenedor GV. Retainer GV. Retenue GV.	75000006	0,87	8431206750062	0,03	2

J/40

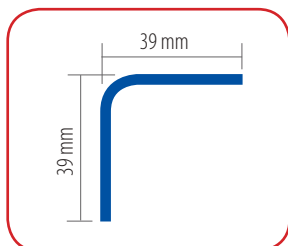
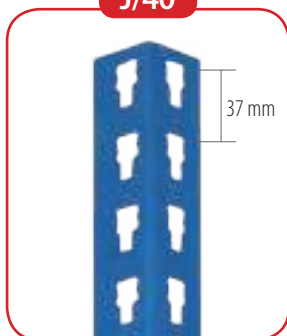

## Perfiles / Uprights / Montants

Artículo L Item L Article L	Ref. Azul Ref. Blue Réf. Bleu	€/Unidad €/Unit €/Unité	Código EAN EAN Code Code EAN	Peso kg Weight kg Poids kg	Uds. Paquete Units Package Unités Paquet
J/40 de 1998	75034020	7,20	8431206751113	1,83	10
J/40 de 2479	75034025	8,93	8431206751137	2,27	10
J/40 de 2997	75034030	10,80	8431206751151	2,75	10

RAL 5010 Azul / Blue / Bleu

## Fondos "L" / "L" Cross beams / Traverses "L"

Artículo L Item L Article L	Ref. Naranja Ref. Orange Réf. Orange	€/Unidad €/Unit €/Unité	Código EAN EAN Code Code EAN	Peso kg Weight kg Poids kg	Uds. Paquete Units Package Unités Paquet
L0300 / L	75041030	1,99	8431206751038	0,30	10
L0450 / L	75041045	2,98	8431206751045	0,45	10
L0600 / L	75041060	3,97	8431206751069	0,60	10
L0750 / L	75041075	4,96	8431206751083	0,75	10
L0900 / L	75041090	5,95	8431206751090	0,90	10
L1000 / L	75041100	6,61	8431206751106	1,00	10

RAL 2004 Naranja / Orange / Orange

## Largueros "C" / "C" Beams / Lisses "C"

Artículo L Item L Article L	Ref. Naranja Ref. Orange Réf. Orange	€/Unidad €/Unit €/Unité	Código EAN EAN Code Code EAN	Peso kg Weight kg Poids kg	Uds. Paquete Units Package Unités Paquet
L0900 / C	75042090	7,36	8431206752097	1,15	10
L1200 / C	75042120	9,81	8431206752127	1,53	10
L1500 / C	75042150	12,26	8431206752158	1,91	10
L1800 / C	75042180	14,71	8431206752189	2,74	6
L2100 / C	75042210	17,16	8431206752219	3,20	6
L2400 / C	75042240	19,61	8431206752240	3,66	6

RAL 2004 Naranja / Orange / Orange

## Travesaños de refuerzo / Deck supports / Barres de renforcement

Artículo L Item L Article L	Ref. Naranja Ref. Orange Réf. Orange	€/Unidad €/Unit €/Unité	Código EAN EAN Code Code EAN	Peso kg Weight kg Poids kg	Uds. Paquete Units Package Unités Paquet
L0450	75093045	3,00	8431206753049	0,44	10
L0600	75093060	3,68	8431206753063	0,57	10
L0750	75093075	4,36	8431206753087	0,70	10
L0900	75093090	5,04	8431206753094	0,83	10
L1000	75093100	5,49	8431206753100	0,92	10
L1200	75093120	6,40	8431206753124	1,09	10
L1500	75093150	7,76	8431206753155	1,35	10

Galvanizado / Galvanised / Galvanisée

## Baldas / Shelves / Tablettes

Artículo LxP Item LxD Article LxP	Referencia Reference Référence	€/Unidad €/Unit €/Unité	Cod. EAN EAN Code Code EAN	Peso kg Weight kg Poids kg	Uds. Paquete Units Package Unités Paquet
300 x 300	75094030	5,56	8431206754039	0,75	10
450 x 300	75094045	6,87	8431206754046	1,04	10
600 x 300	75094060	8,18	8431206754060	1,33	10
750 x 300	75094075	9,49	8431206754084	1,62	10
900 x 300	75094090	10,80	8431206754091	1,91	10
1000 x 300	75094100	11,67	8431206754107	2,09	10

Galvanizado / Galvanised / Galvanisée

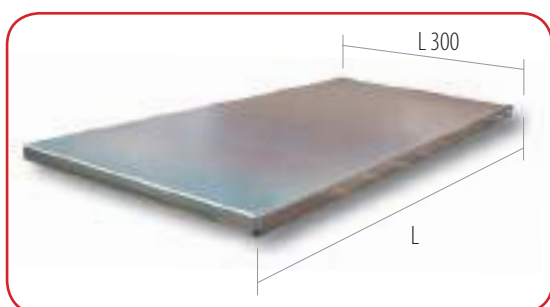
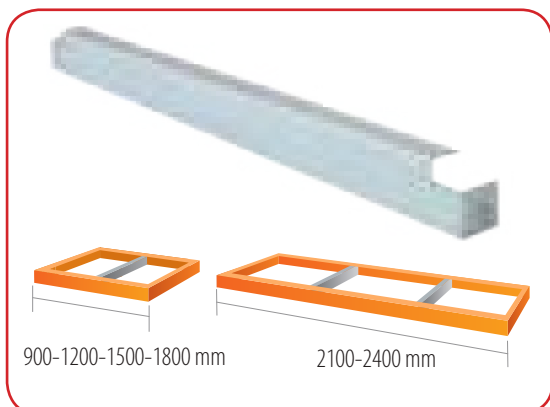
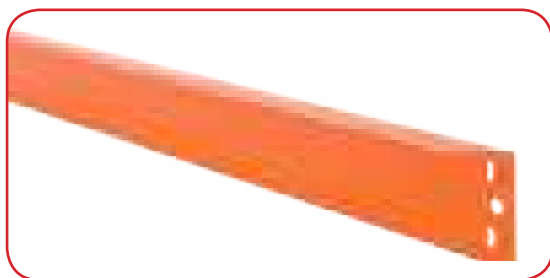

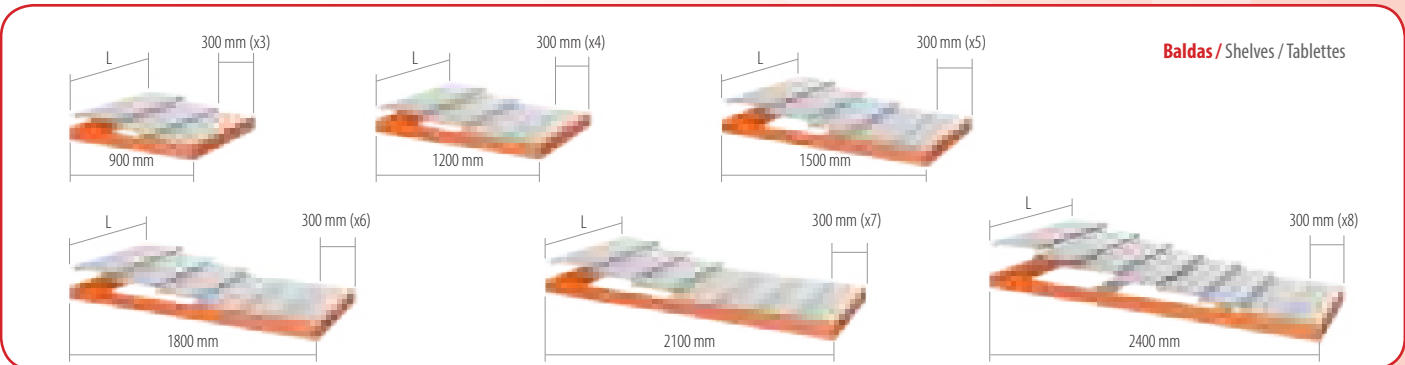
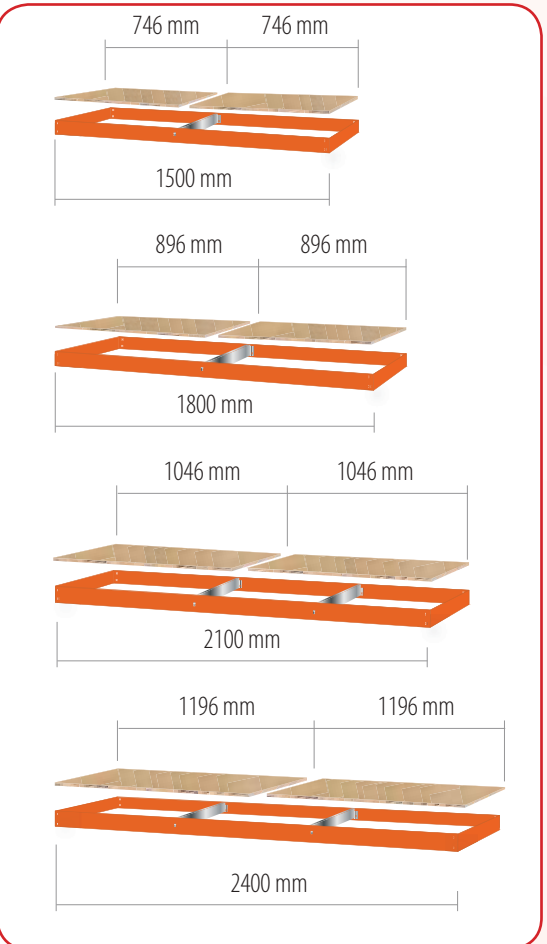
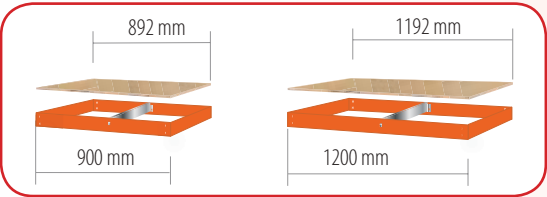
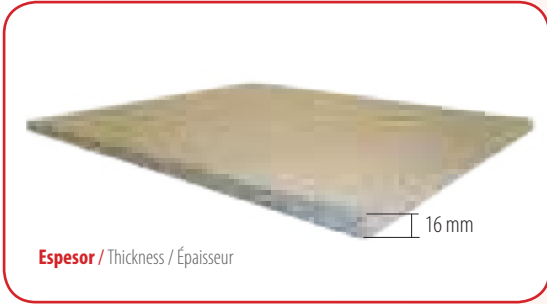

### Aglomerado 1 pieza / Chipboard 1 item / Aggloméré 1 pièce

Artículo LxP Item LxD Article LxP	Referencia Reference Référence	€/Unidad €/Unit €/Unité	Cod. EAN EAN Code Code EAN	Peso kg Weight kg Poids kg	Uds. Paquete Units Package Unités par paquet
892 x 294	75090030	5,82	8431206750932	2,66	1
892 x 444	75090045	8,73	8431206750949	4,10	1
892 x 594	75090060	11,60	8431206750963	5,43	1
892 x 744	75090075	14,51	8431206750970	6,76	1
892 x 894	75090090	17,42	8431206750994	8,19	1
892 x 994	75090100	19,39	8431206750901	9,11	1
1192 x 294	75120030	7,75	8431206751236	3,58	1
1192 x 444	75120045	11,60	8431206751243	5,43	1
1192 x 594	75120060	15,51	8431206751267	7,27	1
1192 x 744	75120075	19,35	8431206751274	9,11	1
1192 x 894	75120090	23,26	8431206751298	10,96	1
1192 x 994	75120100	25,80	8431206751205	12,08	1

### Aglomerado 2 piezas / Chipboard 2 items / Aggloméré 2 pièces

Artículo LxP Item LxD Article LxP	Referencia Reference Référence	€/Unidad €/Unit €/Unité	Cod. EAN EAN Code Code EAN	Peso kg Weight kg Poids kg	Uds. Paquete Units Package Unités par paquet
746 + 746 x 294	75150030	9,56	8431206751533	4,51	1 + 1
746 + 746 x 444	75150045	14,32	8431206751540	6,76	1 + 1
746 + 746 x 594	75150060	19,12	8431206751564	9,11	1 + 1
746 + 746 x 744	75150075	23,85	8431206751571	11,37	1 + 1
746 + 746 x 894	75150090	28,62	8431206751595	13,62	1 + 1
746 + 746 x 994	75150100	31,81	8431206751502	15,16	1 + 1
896 + 896 x 294	75180030	11,60	8431206751830	5,43	1 + 1
896 + 896 x 444	75180045	17,42	8431206751847	8,19	1 + 1
896 + 896 x 594	75180060	23,26	8431206751861	10,85	1 + 1
896 + 896 x 744	75180075	29,08	8431206751878	13,62	1 + 1
896 + 896 x 894	75180090	34,86	8431206751892	16,38	1 + 1
896 + 896 x 994	75180100	38,73	8431206751809	18,23	1 + 1
1046 + 1046 x 294	75210030	13,42	8431206752134	6,35	1 + 1
1046 + 1046 x 444	75210045	20,16	8431206752141	9,52	1 + 1
1046 + 1046 x 594	75210060	26,85	8431206752165	12,70	1 + 1
1046 + 1046 x 744	75210075	33,59	8431206752172	15,97	1 + 1
1046 + 1046 x 894	75210090	40,27	8431206752196	19,15	1 + 1
1046 + 1046 x 994	75210100	44,73	8431206752103	21,30	1 + 1
1196 + 1196 x 294	75240030	15,47	8431206752431	7,17	1 + 1
1196 + 1196 x 444	75240045	23,26	8431206752448	10,85	1 + 1
1196 + 1196 x 594	75240060	30,98	8431206752462	14,54	1 + 1
1196 + 1196 x 744	75240075	38,77	8431206752479	18,23	1 + 1
1196 + 1196 x 894	75240090	46,49	8431206752493	21,91	1 + 1
1196 + 1196 x 994	75240100	51,64	8431206752400	24,37	1 + 1

# kits juegos completos / complete kits / Kits étagère

Aglomerado / Chipboard / Aggloméré



1200.450.3 / 1200.600.3



1500.450.3 / 1500.600.3

**J 40**

**Carga admisible: 1750 kg\***  
Allowable load (kg)  
Charge admissible (kg)



**Sin tornillos**  
Without bolts  
Sans vis



**Martillo nylon**  
Nylon hammer  
Marteau nylon



**Tiempo de montaje**  
Assembly time  
Temps de montage

Larguero Beam Longueron	L/1200	L/1500	L/1800
	500 kg	500 kg	500 kg

Instrucciones de montaje / Assembly instructions / Instructions d'assemblage

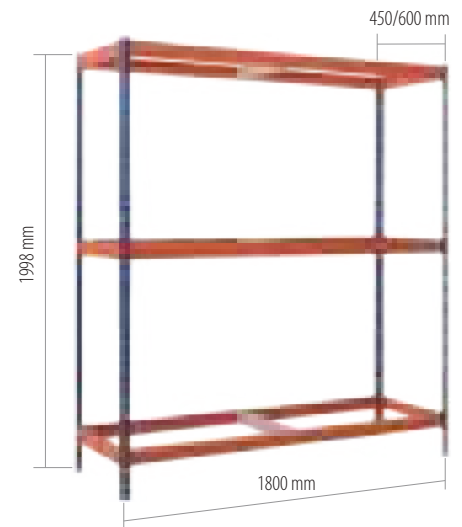
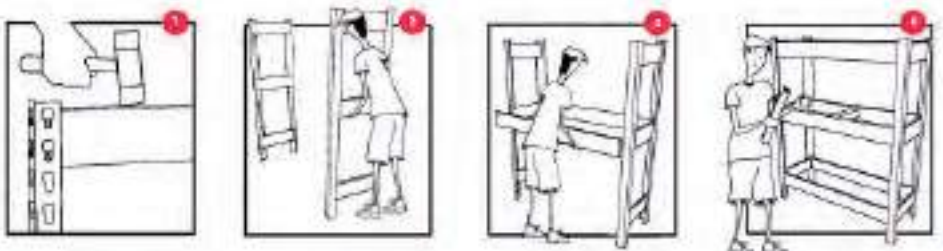

1800.450.3 / 1800.600.3



**Unidades**  
Units / Unités

1200.450.3 / 1200.600.3



**4**  
1998 mm



**4**  
40 x 40 mm



**6**  
450/600 mm



**6**  
1200 mm



**3**  
450/600 mm

### J600 3 niveles / J600 3 levels / J600 3 niveaux

Artículo Item Article	Ref. Azul / Naranja Ref. Blue / Orange Réf. Bleu / Orange	€/Unidad €/Unit €/Unité	Cod. EAN EAN Code Code EAN	Peso kg Weight kg Poids kg	Uds. paquete Units package Unités par paquet	Dim. packaging Dim. packaging Dim. de l'emballage	Unidades palé Pallet units Unités par palettes
J600/1200.450.3	75031243	115,09	8431206752431	20,52	1	2000H x 120W x 80D	30
J600/1200.600.3	75031263	123,08	8431206752639	21,81	1	2000H x 120W x 80D	30

RAL 5010 Azul / Blue / Bleu RAL 2004 Naranja / Orange / Orange



### Aglomerado / Chipboard / Aggloméré

Artículo Item Article	Referencia Reference Référence	€/Envase €/Pack €/Emballage	Cod. EAN EAN Code Code EAN	Peso kg Weight kg Poids kg	Uds. envase Units pack Unités emballage	Dim. packaging Dim. packaging Dim. de l'emballage	Unidades palé Pallet units Unités par palettes
1192 x 444	75120453	34,80	8431206124535	16,29	3	1192W x 444D x 48H	30
1192 x 594	75120603	46,53	8431206126034	21,81	3	1192W x 594D x 48H	30

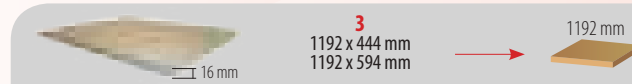

**Unidades**  
Units / Unités

1500.450.3 / 1500.600.3



**4**  
1998 mm



**4**  
40 x 40 mm



**6**  
450/600 mm



**6**  
1500 mm



**3**  
450/600 mm

### J600 3 niveles / J600 3 levels / J600 3 niveaux

Artículo Item Article	Ref. Azul / Naranja Ref. Blue / Orange Réf. Bleu / Orange	€/Unidad €/Unit €/Unité	Cod. EAN EAN Code Code EAN	Peso kg Weight kg Poids kg	Uds. paquete Units package Unités par paquet	Dim. packaging Dim. packaging Dim. de l'emballage	Unidades palé Pallet units Unités par palettes
J600/1500.450.3	75031543	129,79	8431206755432	22,80	1	2000H x 120W x 80D	30
J600/1500.600.3	75031563	137,78	8431206755630	24,09	1	2000H x 120W x 80D	30

RAL 5010 Azul / Blue / Bleu RAL 2004 Naranja / Orange / Orange



### Aglomerado / Chipboard / Aggloméré

Artículo Item Article	Referencia Reference Référence	€/Envase €/Pack €/Emballage	Cod. EAN EAN Code Code EAN	Peso kg Weight kg Poids kg	Uds. envase Units pack Unités emballage	Dim. packaging Dim. packaging Dim. de l'emballage	Unidades palé Pallet units Unités par palettes
746 + 746 x 444	75075453	42,96	8431206154532	20,28	3 + 3	746W x 444D x 96H	30
746 + 746 x 594	75075603	57,33	8431206156031	27,33	3 + 3	746W x 594D x 96H	30



**Unidades**  
Units / Unités

1800.450.3 / 1800.600.3



**4**  
1998 mm



**4**  
40 x 40 mm



**6**  
450/600 mm



**6**  
1800 mm



**3**  
450/600 mm

### J600 3 niveles / J600 3 levels / J600 3 niveaux

Artículo Item Article	Ref. Azul / Naranja Ref. Blue / Orange Réf. Bleu / Orange	€/Unidad €/Unit €/Unité	Cod. EAN EAN Code Code EAN	Peso kg Weight kg Poids kg	Uds. paquete Units package Unités par paquet	Dim. packaging Dim. packaging Dim. de l'emballage	Unidades palé Pallet units Unités par palettes
J600/1800.450.3	75031843	144,49	8431206758433	27,78	1	2000H x 120W x 80D	30
J600/1800.600.3	75031863	152,48	8431206758631	29,07	1	2000H x 120W x 80D	30

RAL 5010 Azul / Blue / Bleu RAL 2004 Naranja / Orange / Orange



### Aglomerado / Chipboard / Aggloméré

Artículo Item Article	Referencia Reference Référence	€/Envase €/Pack €/Emballage	Cod. EAN EAN Code Code EAN	Peso kg Weight kg Poids kg	Uds. envase Units pack Unités emballage	Dim. packaging Dim. packaging Dim. de l'emballage	Unidades palé Pallet units Unités par palettes
896 + 896 x 444	75090453	52,23	8431206184539	24,57	3 + 3	896W x 444D x 96H	30
896 + 896 x 594	75090603	69,78	8431206186038	32,55	3 + 3	896W x 594D x 96H	30



# kits juegos completos / complete kits / Kits étagère

Aglomerado / Chipboard / Aggloméré

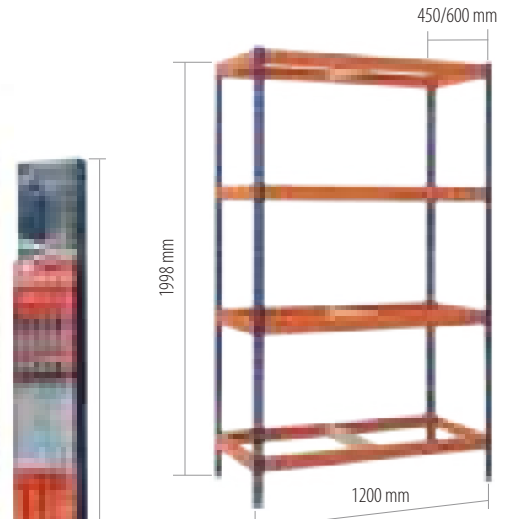

1200.450.4 / 1200.600.4



1500.450.4 / 1500.600.4



1800.450.4 / 1800.600.4

**J 40**

**Carga admisible: 1750 kg\***  
Allowable load (kg)  
Charge admissible (kg)



**Sin tornillos**  
Without bolts  
Sans vis



**Martillo nylon**  
Nylon hammer  
Marteau nylon



**Tiempo de montaje**  
Assembly time  
Temps de montage

Larguero Beam Longueron	L/1200	L/1500	L/1800
	500 kg	500 kg	500 kg

Instrucciones de montaje / Assembly instructions / Instructions d'assemblage

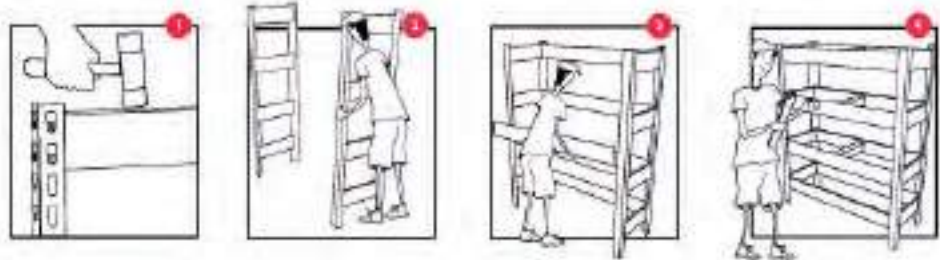

**Unidades**  
Units / Unités

1200.450.4 / 1200.600.4

**4**  
1998 mm

**4**  
40 x 40 mm

**8**  
450/600 mm

**8**  
1200 mm

**4**  
450/600 mm

## J600 4 niveles / J600 4 levels / J600 4 niveaux

Artículo Item Article	Ref. Azul / Naranja Ref. Blue / Orange Réf. Bleu / Orange	€/Unidad €/Unit €/Unité	Cod. EAN EAN Code Code EAN	Peso kg Weight kg Poids kg	Uds. paquete Units package Unités par paquet	Dim. packaging Dim. de l'emballage	Unidades palé Pallet units Unités par palettes
J600/1200.450.4	75031244	143,66	8431206752448	24,92	1	2000H x 145W x 80D	25
J600/1200.600.4	75031264	154,32	8431206752646	26,64	1	2000H x 145W x 80D	25

RAL 5010 Azul / Blue / Bleu RAL 2004 Naranja / Orange / Orange

## Aglomerado / Chipboard / Aggloméré

Artículo Item Article	Referencia Reference Référence	€/Envase €/Pack €/Emballage	Cod. EAN EAN Code Code EAN	Peso kg Weight kg Poids kg	Uds. envase Units pack Unités emballage	Dim. packaging Dim. de l'emballage	Unidades palé Pallet units Unités par palettes
1192 x 444	75120454	46,40	8431206124542	21,72	4	1192W x 444D x 64H	25
1192 x 594	75120604	62,04	8431206126041	29,08	4	1192W x 594D x 64H	25

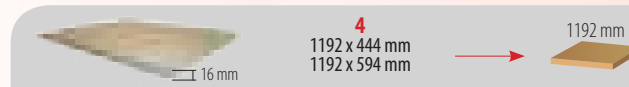

**Unidades**  
Units / Unités

1500.450.4 / 1500.600.4

**4**  
1998 mm

**4**  
40 x 40 mm

**8**  
450/600 mm

**8**  
1500 mm

**4**  
450/600 mm

## J600 4 niveles / J600 4 levels / J600 4 niveaux

Artículo Item Article	Ref. Azul / Naranja Ref. Blue / Orange Réf. Bleu / Orange	€/Unidad €/Unit €/Unité	Cod. EAN EAN Code Code EAN	Peso kg Weight kg Poids kg	Uds. paquete Units package Unités par paquet	Dim. packaging Dim. de l'emballage	Unidades palé Pallet units Unités par palettes
J600/1500.450.4	75031544	163,26	8431206755449	27,96	1	2000H x 145W x 80D	25
J600/1500.600.4	75031564	173,92	8431206755647	29,68	1	2000H x 145W x 80D	25

RAL 5010 Azul / Blue / Bleu RAL 2004 Naranja / Orange / Orange

## Aglomerado / Chipboard / Aggloméré

Artículo Item Article	Referencia Reference Référence	€/Envase €/Pack €/Emballage	Cod. EAN EAN Code Code EAN	Peso kg Weight kg Poids kg	Uds. envase Units pack Unités emballage	Dim. packaging Dim. de l'emballage	Unidades palé Pallet units Unités par palettes
746 + 746 x 444	75075454	57,28	8431206154549	27,04	4 + 4	746W x 444D x 128H	25
746 + 746 x 594	75075604	76,44	8431206156048	36,44	4 + 4	746W x 594D x 128H	25



**Unidades**  
Units / Unités

1800.450.4 / 1800.600.4

**4**  
1998 mm

**4**  
40 x 40 mm

**8**  
450/600 mm

**8**  
1800 mm

**4**  
450/600 mm

## J600 4 niveles / J600 4 levels / J600 4 niveaux

Artículo Item Article	Ref. Azul / Naranja Ref. Blue / Orange Réf. Bleu / Orange	€/Unidad €/Unit €/Unité	Cod. EAN EAN Code Code EAN	Peso kg Weight kg Poids kg	Uds. paquete Units package Unités par paquet	Dim. packaging Dim. de l'emballage	Unidades palé Pallet units Unités par palettes
J600/1800.450.4	75031844	182,86	8431206758440	34,60	1	2000H x 145W x 80D	25
J600/1800.600.4	75031864	193,52	8431206758648	36,32	1	2000H x 145W x 80D	25

RAL 5010 Azul / Blue / Bleu RAL 2004 Naranja / Orange / Orange

## Aglomerado / Chipboard / Aggloméré

Artículo Item Article	Referencia Reference Référence	€/Envase €/Pack €/Emballage	Cod. EAN EAN Code Code EAN	Peso kg Weight kg Poids kg	Uds. envase Units pack Unités emballage	Dim. packaging Dim. de l'emballage	Unidades palé Pallet units Unités par palettes
896 + 896 x 444	75090454	69,64	8431206184546	32,76	4 + 4	896W x 444D x 128H	25
896 + 896 x 594	75090604	93,04	8431206186045	43,40	4 + 4	896W x 594D x 128H	25



### bancos de trabajo / work benches / bancs de travail

Artículo Item Article	Ref. Azul / Naranja Ref. Blue / Orange Réf. Bleu / Orange	€/ Unidad €/ Unit €/ Unité	Cod. EAN EAN Code Code EAN	Peso kg Weight kg Poids kg	Uds. paquete Units package Unités paquet	Dim. packaging Dim. packaging Dim. d'emballage	Unidades palé Pallet units Unités palettes
BTS / 900	75030091	87,49	8431206750093	21,64	1	900H x 600W x 70D	16
BTS / 1200	75030121	105,11	8431206750123	26,84	1	1200H x 600W x 70D	16
BTS / 1500	75030151	122,09	8431206750154	32,04	1	1500H x 600W x 70D	16

RAL 5010 Azul / Blue / Bleu RAL 2004 Naranja / Orange / Orange

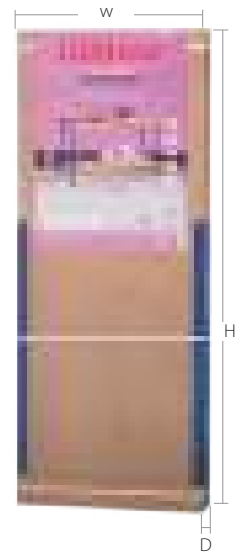

**OPCIONAL:** Melamina canteada y sin cantear, consultar.  
**OPTIONAL:** Melamine edged and without edged, consult.  
**OPTIONNEL:** Mélamine bordée et non bordée, consulter.

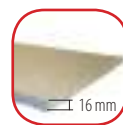

Sin tornillos  
Without bolts  
Sans vis



Martillo nylon  
Nylon hammer  
Marteau nylon



Tiempo de montaje  
Assembly time  
Temps d'assemblage





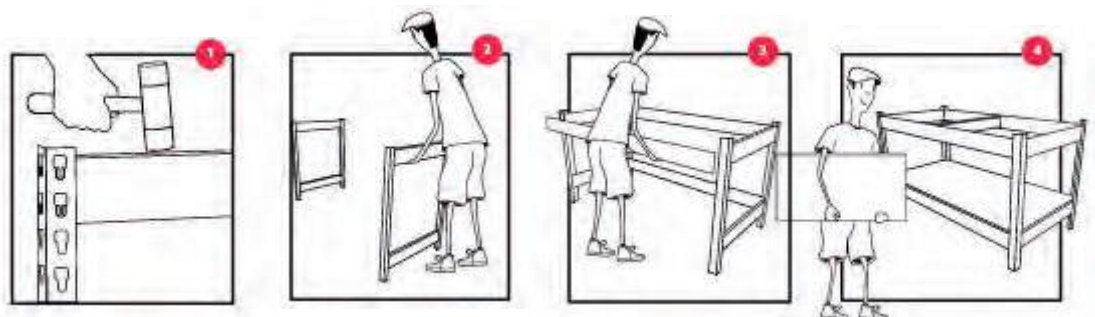

#### Instrucciones de montaje

Assembly instructions







Instructions d'assemblage







**Unidades**  
Units / Unités  
**BTS / 900**

	<b>4</b> 888 mm
	<b>4</b> 35 x 35 mm
	<b>4</b> 600 mm
	<b>4</b> 900 mm
	<b>2</b> 600 mm
	<b>2</b> 892 x 594 mm

**Unidades**  
Units / Unités  
**BTS / 1200**

	<b>4</b> 888 mm
	<b>4</b> 35 x 35 mm
	<b>4</b> 600 mm
	<b>4</b> 1200 mm
	<b>2</b> 600 mm
	<b>2</b> 1192 x 594 mm

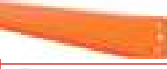
**Unidades**  
Units / Unités  
**BTS / 1500**

	<b>4</b> 888 mm
	<b>4</b> 35 x 35 mm
	<b>4</b> 600 mm
	<b>4</b> 1500 mm
	<b>2</b> 600 mm
	<b>2</b> 1492 x 594 mm

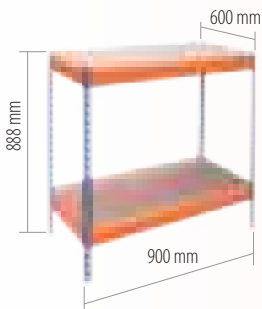

**BTS 900**

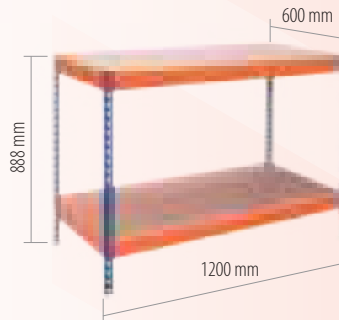



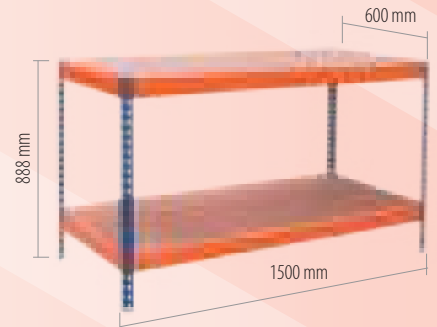

**BTS 1200**

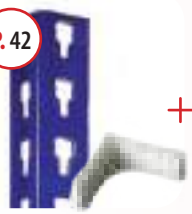

**BTS 1500**

Configure su banco de trabajo según su necesidad  
Configure your workbench as needed / Configurez votre établi de travail selon vos besoins

Perfil Upright / Montant	Fondo "L" "L" Cross beam / Lisse	Larguero "C" "C" Beam / Traverse C	Travesaño de refuerzo Deck support / Barre de renfort	Aglomerado Chipboard / Aggloméré														
 <b>P. 42</b>	 <b>P. 30</b>	 <b>P. 30</b>	 <b>P. 30</b>	 <b>P. 31</b>														
888	300 450 600 750 900 1000	900 1200 1500 1800 2100* 2400*	450 600 750 900 1000	<table border="1"> <thead> <tr> <th>W</th> <th>D</th> </tr> </thead> <tbody> <tr><td>892</td><td>294</td></tr> <tr><td>1192</td><td>444</td></tr> <tr><td>1492**</td><td>594</td></tr> <tr><td>1792**</td><td>744</td></tr> <tr><td>2092**</td><td>894</td></tr> <tr><td>2392**</td><td>994</td></tr> </tbody> </table>	W	D	892	294	1192	444	1492**	594	1792**	744	2092**	894	2392**	994
W	D																	
892	294																	
1192	444																	
1492**	594																	
1792**	744																	
2092**	894																	
2392**	994																	

\*Necesarios 2 travesaños de refuerzo por nivel / 2 Decks support required per level / 2 Barres de renfort requis par niveau

\*\* En 2 piezas / In 2 pieces / En 2 pièces

### bancos de trabajo / work benches / bancs de travail

Artículo Item Article	Ref. Azul / Naranja Ref. Blue / Orange Réf. Bleu / Orange	€/ Unidad €/ Unit €/ Unité	Cod. EAN EAN Code Code EAN	Peso kg Weight kg Poids kg	Uds. paquete Units package Unités paquet	Dim. pakaging Dim. packaging Dim. d'emballage	Unidades palé Pallet units Unités palettes
BTP / 900	75030092	127,89	8431206750192	28,38	1	1500H x 600W x 70D	16
BTP / 1200	75030122	155,65	8431206750222	35,36	1	1500H x 600W x 70D	16
BTP / 1500	75030152	182,75	8431206750253	42,36	1	1500H x 600W x 70D	16

RAL 5010 Azul / Blue / Bleu RAL 2004 Naranja / Orange / Orange

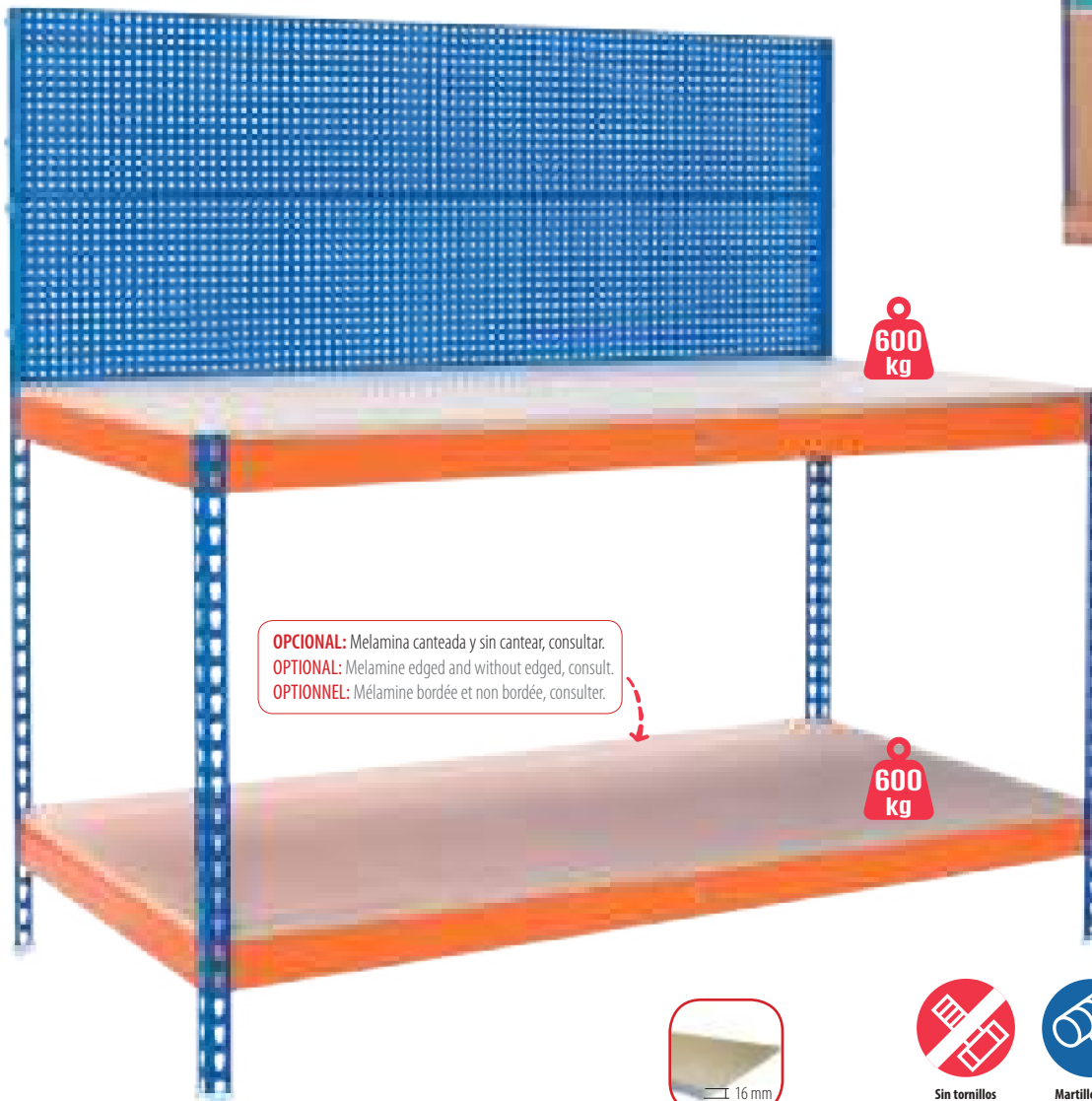
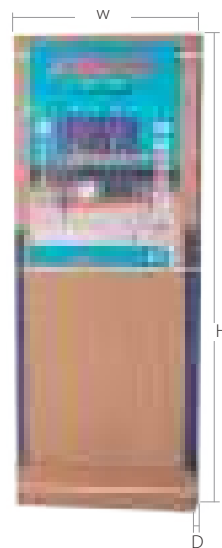

**Sin tornillos**  
Without bolts  
Sans vis



**Martillo nylon**  
Nylon hammer  
Marteau nylon









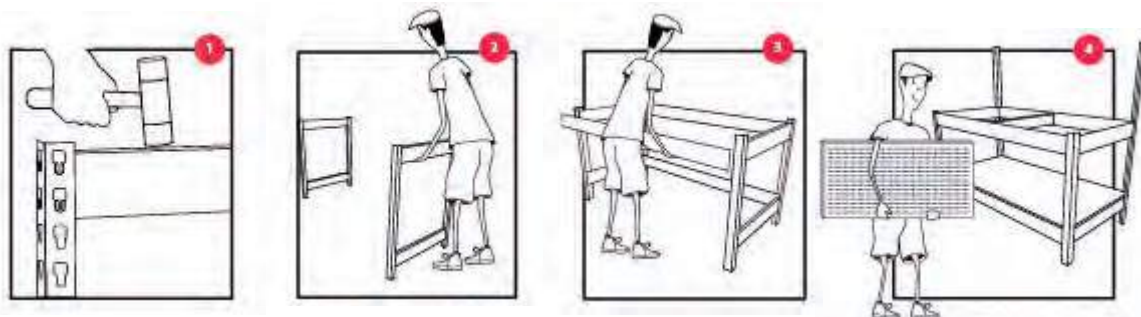

**Tiempo de montaje**  
Assembly time  
Temps d'assemblage









#### Instrucciones de montaje









Assembly instructions

Instructions d'assemblage



Unidades Units / Unités	
BTP / 900	
	2 888 mm 2 1480 mm
	4 35 x 35 mm
	4 600 mm
	4 900 mm
	2 600 mm
	2 892 x 594 mm
	2 900 x 300 mm
	10

Unidades Units / Unités	
BTP / 1200	
	2 888 mm 2 1480 mm
	4 35 x 35 mm
	4 600 mm
	4 1200 mm
	2 600 mm
	2 1192 x 594 mm
	2 1200 x 300 mm
	10

Unidades Units / Unités	
BTP / 1500	
	2 888 mm 2 1480 mm
	4 35 x 35 mm
	4 600 mm
	4 1500 mm
	2 600 mm
	2 1492 x 594 mm
	2 1500 x 300 mm
	10

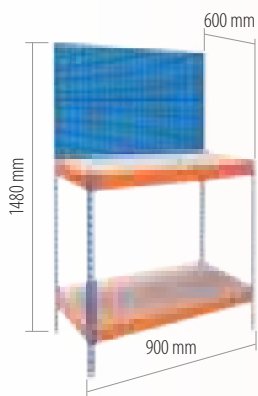

BTP 900

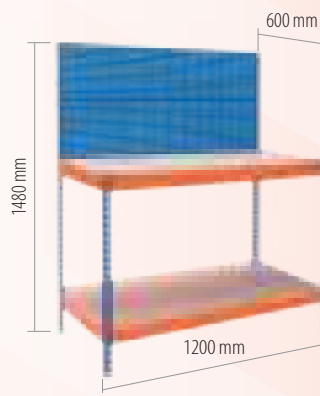



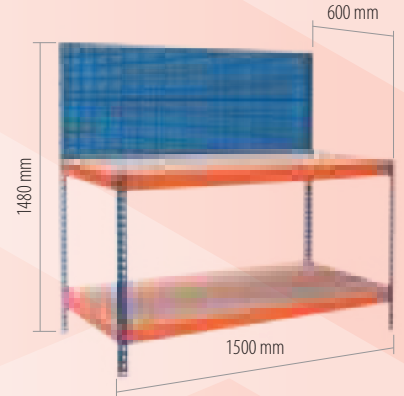



BTP 1200

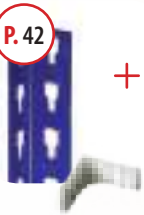

BTP 1500

## Configure su banco de trabajo según su necesidad

Configure your workbench as needed / Configurez votre établi de travail selon vos besoins

Perfil Upright Montant	Fondo "L" "L" Cross beam Lisse "L"	Larguero "C" "C" Beam Traverse C	Travesaño de refuerzo Deck support Barre de renfort	Aglomerado Chipboard Aggloméré	Panel Perforado Perfo panels panneaux porte-outils
					
<b>P. 42</b>	<b>P. 30</b>	<b>P. 30</b>	<b>P. 30</b>	<b>P. 31</b>	<b>P. 43</b>
888 1480	300 450 600 750 900 1000	900 1200 1500	450 600 750 900 1000 1200 1500	W D 892 1192 1492*	H W 300 900 1200 1500

\* En 2 piezas / In 2 pieces / En 2 pièces

### bancos de trabajo / work benches / bancs de travail

Artículo Item Article	Ref. Azul / Naranja Ref. Blue / Orange Réf. Bleu / Orange	€/ Unidad €/ Unit €/ Unité	Cod. EAN EAN Code Code EAN	Peso kg Weight kg Poids kg	Uds. paquete Units package Unités paquet	Dim. packaging Dim. packaging Dim. d'emballage	Unidades palé Pallet units Unités palettes
BTE / 900	75030093	155,02	8431206750291	38,04	1	1500H x 750W x 70D	14
BTE / 1200	75030123	188,15	8431206750321	47,62	1	1500H x 750W x 70D	14
BTE / 1500	75030153	220,37	8431206750352	57,04	1	1500H x 750W x 70D	14

RAL 5010 Azul / Blue / Bleu RAL 2004 Naranja / Orange / Orange

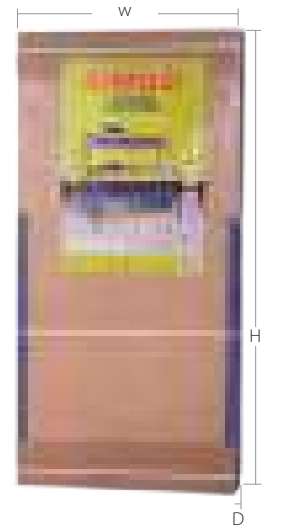

**OPCIONAL:** Melamina canteada y sin cantear, consultar.  
**OPTIONAL:** Melamine edged and without edged, consult.  
**OPTIONNEL:** Mèlamine bordée et non bordée, consulter.



Sin tornillos  
Without bolts  
Sans vis



Martillo nylon  
Nylon hammer  
Marteau nylon



Tiempo de montaje  
Assembly time  
Temps d'assemblage

Instrucciones de montaje

Assembly instructions



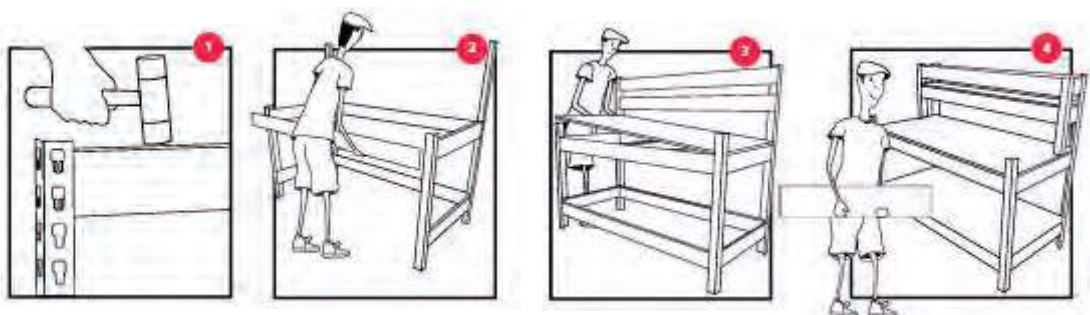



Instructions d'assemblage





**Unidades**  
Units / Unités

**BTE / 900**



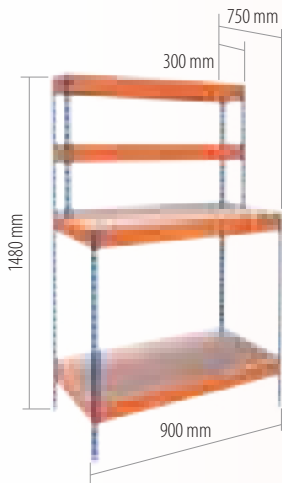



	2 592 mm 2 888 mm 2 1480 mm
	4 35 x 35 mm
	4 300 mm 4 750 mm
	8 900 mm
	2 750 mm
	2 892 x 294 mm 2 892 x 744 mm



**BTE 900**

**Unidades**  
Units / Unités

**BTE / 1200**



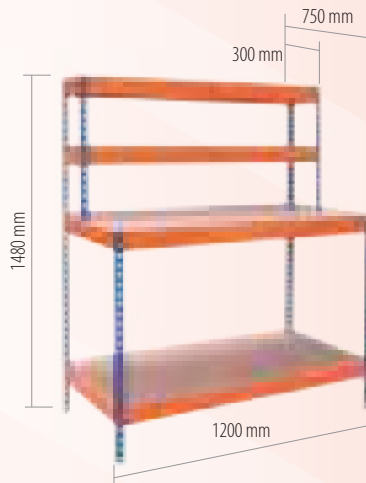



	2 592 mm 2 888 mm 2 1480 mm
	4 35 x 35 mm
	4 300 mm 4 750 mm
	8 1200 mm
	2 750 mm
	2 1192 x 294 mm 2 1192 x 744 mm



**BTE 1200**

**Unidades**  
Units / Unités



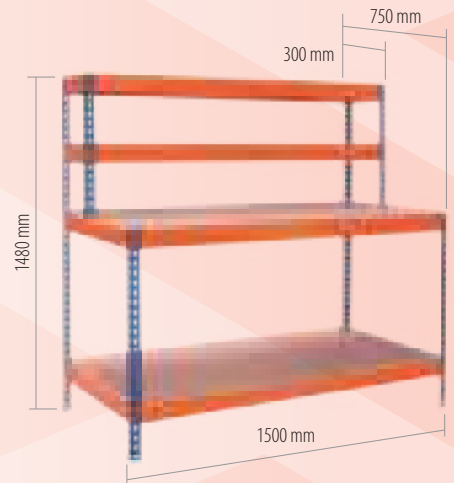

**BTE / 1500**

	2 592 mm 2 888 mm 2 1480 mm
	4 35 x 35 mm
	4 300 mm 4 750 mm
	8 1500 mm
	2 750 mm
	2 1492 x 294 mm 2 1492 x 744 mm

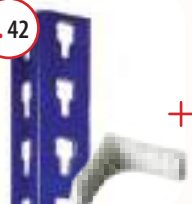

**BTE 1500**

Configure su banco de trabajo según su necesidad  
Configure your workbench as needed / Configurez votre établi de travail selon vos besoins

Perfil Upright / Montant	Fondo "L" "L" Cross beam / Lisse	Larguero "C" "C" Beam / Traverse C	Travesaño de refuerzo Deck support / Barre de renfort	Aglomerado Chipboard / Aggloméré														
 <b>P. 42</b>	 <b>P. 30</b>	 <b>P. 30</b>	 <b>P. 30</b>	 <b>P. 31</b>														
592 888 1480	300 450 600 750 900 1000	900 1200 1500 1800 2100* 2400*	450 600 750 900 1000	<table border="1"> <thead> <tr><th>W</th><th>D</th></tr> </thead> <tbody> <tr><td>892</td><td>294</td></tr> <tr><td>1192</td><td>444</td></tr> <tr><td>1492**</td><td>594</td></tr> <tr><td>1792**</td><td>744</td></tr> <tr><td>2092**</td><td>894</td></tr> <tr><td>2392**</td><td>994</td></tr> </tbody> </table>	W	D	892	294	1192	444	1492**	594	1792**	744	2092**	894	2392**	994
W	D																	
892	294																	
1192	444																	
1492**	594																	
1792**	744																	
2092**	894																	
2392**	994																	

\*Necesarios 2 travesaños de refuerzo por nivel / 2 Decks support required per level / 2 Barres de renfort requis par niveau

\*\* En 2 piezas / In 2 pieces / En 2 pièces

J/35

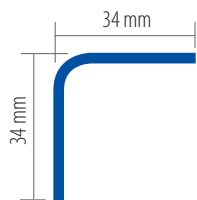
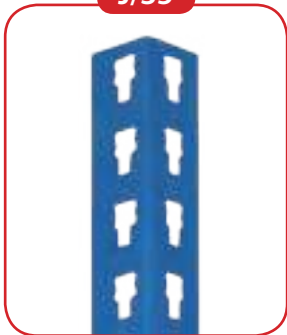

### Perfiles / Uprights / Montants

Artículo L Item L Article L	Ref. Naranja Ref. Orange Réf. Orange	€/Unidad €/Unit €/Unité	Código EAN EAN Code Code EAN	Peso kg Weight kg Poids kg	Uds. Paquete Units Package Unités Paquet
J/35 de 592	73033506	1,84	8431206731023	0,44	2
J/35 de 814	73033508	2,53	8431206731047	0,58	2
J/35 de 888	73033509	2,76	8431206731054	0,66	2
J/35 de 1480	73033515	4,59	8431206731085	1,10	2

RAL 5010 Azul / Blue / Bleu



### Fondos "L-I" / "L-I" Cross beams / Traverses "L-I"

Artículo L - I Item L - I Article L - I	Ref. Naranja Ref. Orange Réf. Orange	€/Unidad €/Unit €/Unité	Código EAN EAN Code Code EAN	Peso kg Weight kg Poids kg	Uds. Paquete Units Package Unités Paquet
L0300 / L-I	75045030	1,99	8431206755036	0,30	10
L0450 / L-I	75045045	2,98	8431206755043	0,45	10
L0600 / L-I	75045060	3,97	8431206755067	0,60	10
L0750 / L-I	75045075	4,96	8431206755074	0,75	10
L0900 / L-I	75045090	5,95	8431206755098	0,90	10
L1000 / L-I	75045100	6,61	8431206755104	1,00	10

RAL 2004 Naranja / Orange / Orange



Sin tornillos  
Without bolts  
Sans vis



Martillo nylon  
Nylon hammer  
Marteau nylon



**OPCIONAL:** Melamina canteada y sin cantear, consultar.  
**OPTIONAL:** Melamine edged and without edged, consult.  
**OPTIONNEL:** Mèlamine bordée et non bordée, consulter.



P. 42

**Perfiles no incluidos, necesarios para sujeción a pared**  
Uprights not included, necessary for wall mounting  
Montants non inclus, nécessaires pour le montage mural



## Paneles perforados / Perfo panels / Panneaux porte-outils

Artículo LxH Item LxP Article LxP	Ref. Azul Ref. Blue Réf. Bleu	€/Unidad €/Unit €/Unité	Código EAN EAN Code Code EAN	Peso kg Weight kg Poids kg	Uds. Paquete Units Package Unités Paquet
900 x 300	75PP030903	15,57	8431206750406	2,90	2
1200 x 300	75PP031203	20,64	8431206750413	3,79	2
1500 x 300	75PP031503	25,70	8431206750420	4,69	2

RAL 5010 Azul / Blue / Bleu



75GSC - ECO  
**20 uds.**

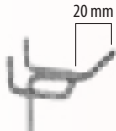

75GSC - 405  
**10 uds.**

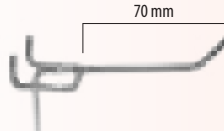

75GSC - 410  
**10 uds.**

## Ganchos / Hooks / Crochets

Artículo Item Article	Referencia Referencia Referencia	€/Envase €/Pack €/Emballage	Código EAN EAN Code Code EAN	Peso kg Weight kg Poids kg	Uds. Envase Units Pack Unités del l'emballage
45 - Ø 5	75GSC-ECO	11,20	8431206750437	0,28	20
20 - Ø 4	75GSC-405	8,23	8431206750444	0,18	10
70 - Ø 4	75GSC-410	8,23	8431206750451	0,23	10

## Configure su banco de trabajo según su necesidad

Configure your workbench as needed / Configurez votre établi de travail selon vos besoins

**Perfil**  
Upright  
Montant

P. 42



592  
888  
1480

**Fondo "L-I"**  
"L - I" Cross beam  
Lisse "L - I"

P. 42



300  
450  
600  
750  
900  
1000

**Fondo "L"**  
"L" Cross beam  
Lisse "C"

P. 30



300  
450  
600  
750  
900  
1000

**Larguero "C"**  
"C" Beam  
Traverse "C"

P. 30



900  
1200  
1500  
1800  
2100\*  
2400\*

**Travesaño de refuerzo**  
Deck support  
Barre de renfort

P. 30



450  
600  
750  
900  
1000  
1200  
1500

**Aglomerado**  
Chipboard  
Aggloméré

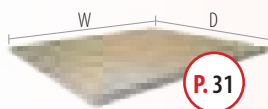

P. 31

W

D

892	294
1192	444
1492**	594
1792**	744
2092**	894
2392**	944

**Paneles perforados**  
Perfo Panels  
Panneaux porte-outils

\*Tornillos Incluidos  
Screws included  
Vis incluses



P. 43

W

H

900  
1200  
1500

**Ganchos**  
Hooks  
Crochets



P. 43

\*Necesarios 2 travesaños de refuerzo por nivel / 2 Decks support required per level / 2 Barres de renfort requis par niveau

\*\*En 2 piezas / In 2 pieces / En 2 pièces



Ref. 75000037



Ref. 75000036

**\*12 uds.**  
\*Tornillos incluidos  
Screws included  
Vis incluses



Ref. 75000038

## Fondos y largueros "R"

Beams and Cross beams "R" / Traverses et Lisses "R"

Artículo L Item L Article L	Ref. Naranja Ref. Orange Réf. Orange	€/Unidad €/Unit €/Unité	Código EAN EAN Code Code EAN	Peso kg Weight kg Poids kg	Uds. Paquete Units Package Unités Paquet
L0220 / R	75046030	2,50	8431206756033	0,28	2
L0370 / R	75046045	3,65	8431206756040	0,48	2
L0520 / R	75046060	4,80	8431206756064	0,67	2
L0670 / R	75046075	5,95	8431206756071	0,86	2
L0820 / R	75046090	7,10	8431206756095	1,05	2
L0920 / R	75046100	7,87	8431206756101	1,18	2
L1120 / R	75046120	9,40	8431206756125	1,44	2
L1420 / R	75046150	11,70	8431206756156	1,84	2
L1720 / R	75046180	14,00	8431206756187	2,65	2
L2020 / R	75046210	16,30	8431206756217	3,11	2
L2320 / R	75046240	18,60	8431206756248	3,57	2

RAL 2004 Naranja / Orange / Orange

## Rueda y adaptador / Wheel and adapter / roue et adaptateur

Artículo L Item L Article L	Ref. Naranja Ref. Orange Réf. Orange	€/Unidad €/Unit €/Unité	Código EAN EAN Code Code EAN	Peso kg Weight kg Poids kg	Uds. Paquete Units Package Unités Paquet
Adaptador Rueda	75000036	14,29	8431206750369	0,24	4
Rueda 60 NYL	75000037	21,50	8431206750376	0,56	2
Rueda 60 FA NYL	75000038	35,30	8431206750383	0,63	2

**!** Carga máxima: 100 kg por rueda / Maximum load: 100 kg per wheel / Charge maximale: 100 kg par roue









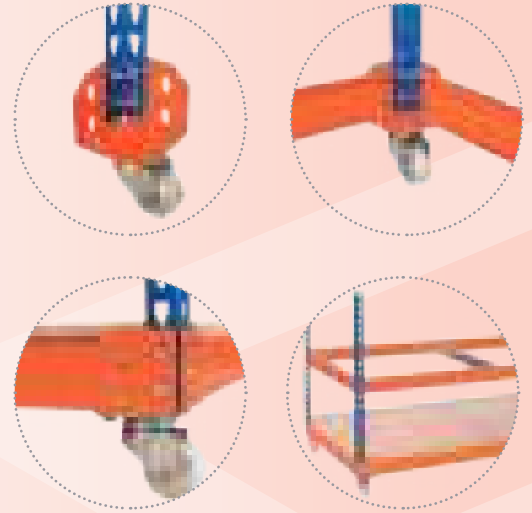

**OPCIONAL:** Melamina canteada y sin cantear, consultar.  
**OPTIONAL:** Melamine edged and without edged, consult.  
**OPTIONNEL:** Mélangine bordée et non bordée, consulter.

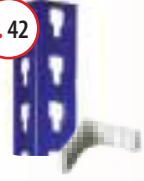

**Martillo nylon**  
Nylon hammer  
Marteau nylon



Configure su banco de trabajo según su necesidad  
Configure your workbench as needed / Configurez votre établi de travail selon vos besoins

<p><b>Perfil</b> Upright Montant</p> <p><b>P. 42</b></p>  <p>814</p>	<p><b>Adaptador ruedas</b> Wheel adapter Adaptateur de roue</p> <p><b>P. 44</b></p> 	<p><b>Ruedas</b> wheels roues</p> <p><b>P. 44</b></p> 	<p><b>Fondo "R"</b> "R" Cross beam Lisse "R"</p> <p><b>P. 44</b></p>  <table border="0"> <tr><td>220</td></tr> <tr><td>370</td></tr> <tr><td>520</td></tr> <tr><td>670</td></tr> <tr><td>820</td></tr> <tr><td>920</td></tr> </table>	220	370	520	670	820	920	<p><b>Larguero "R"</b> "R" Beam Traverse "R"</p> <p><b>P. 44</b></p>  <table border="0"> <tr><td>820</td></tr> <tr><td>1120</td></tr> <tr><td>1420</td></tr> <tr><td>1720</td></tr> <tr><td>2020*</td></tr> <tr><td>2320*</td></tr> </table>	820	1120	1420	1720	2020*	2320*																		
220																																		
370																																		
520																																		
670																																		
820																																		
920																																		
820																																		
1120																																		
1420																																		
1720																																		
2020*																																		
2320*																																		
<p><b>Fondo "L"</b> "L" Cross beam Lisse "C"</p> <p><b>P. 30</b></p>  <table border="0"> <tr><td>300</td></tr> <tr><td>450</td></tr> <tr><td>600</td></tr> <tr><td>750</td></tr> <tr><td>900</td></tr> <tr><td>1000</td></tr> </table>	300	450	600	750	900	1000	<p><b>Larguero "C"</b> "C" Beam Traverse "C"</p> <p><b>P. 30</b></p>  <table border="0"> <tr><td>900</td></tr> <tr><td>1200</td></tr> <tr><td>1500</td></tr> <tr><td>1800</td></tr> <tr><td>2100*</td></tr> <tr><td>2400*</td></tr> </table>	900	1200	1500	1800	2100*	2400*	<p><b>Travesaño de refuerzo</b> Deck support Barre de renfort</p> <p><b>P. 30</b></p>  <table border="0"> <tr><td>450</td></tr> <tr><td>600</td></tr> <tr><td>750</td></tr> <tr><td>900</td></tr> <tr><td>1000</td></tr> </table>	450	600	750	900	1000	<p><b>Aglomerado</b> Chipboard Aggloméré</p> <p><b>P. 31</b></p>  <table border="0"> <thead> <tr> <th>W</th> <th>D</th> </tr> </thead> <tbody> <tr><td>892</td><td>294</td></tr> <tr><td>1192</td><td>444</td></tr> <tr><td>1492**</td><td>594</td></tr> <tr><td>1792**</td><td>744</td></tr> <tr><td>2092**</td><td>894</td></tr> <tr><td>2392**</td><td>944</td></tr> </tbody> </table>	W	D	892	294	1192	444	1492**	594	1792**	744	2092**	894	2392**	944
300																																		
450																																		
600																																		
750																																		
900																																		
1000																																		
900																																		
1200																																		
1500																																		
1800																																		
2100*																																		
2400*																																		
450																																		
600																																		
750																																		
900																																		
1000																																		
W	D																																	
892	294																																	
1192	444																																	
1492**	594																																	
1792**	744																																	
2092**	894																																	
2392**	944																																	

\*Necesarios 2 travesaños de refuerzo por nivel / 2 Decks support required per level / 2 Barres de renfort requis par niveau  
\*\*En 2 piezas / In 2 pieces / En 2 pièces

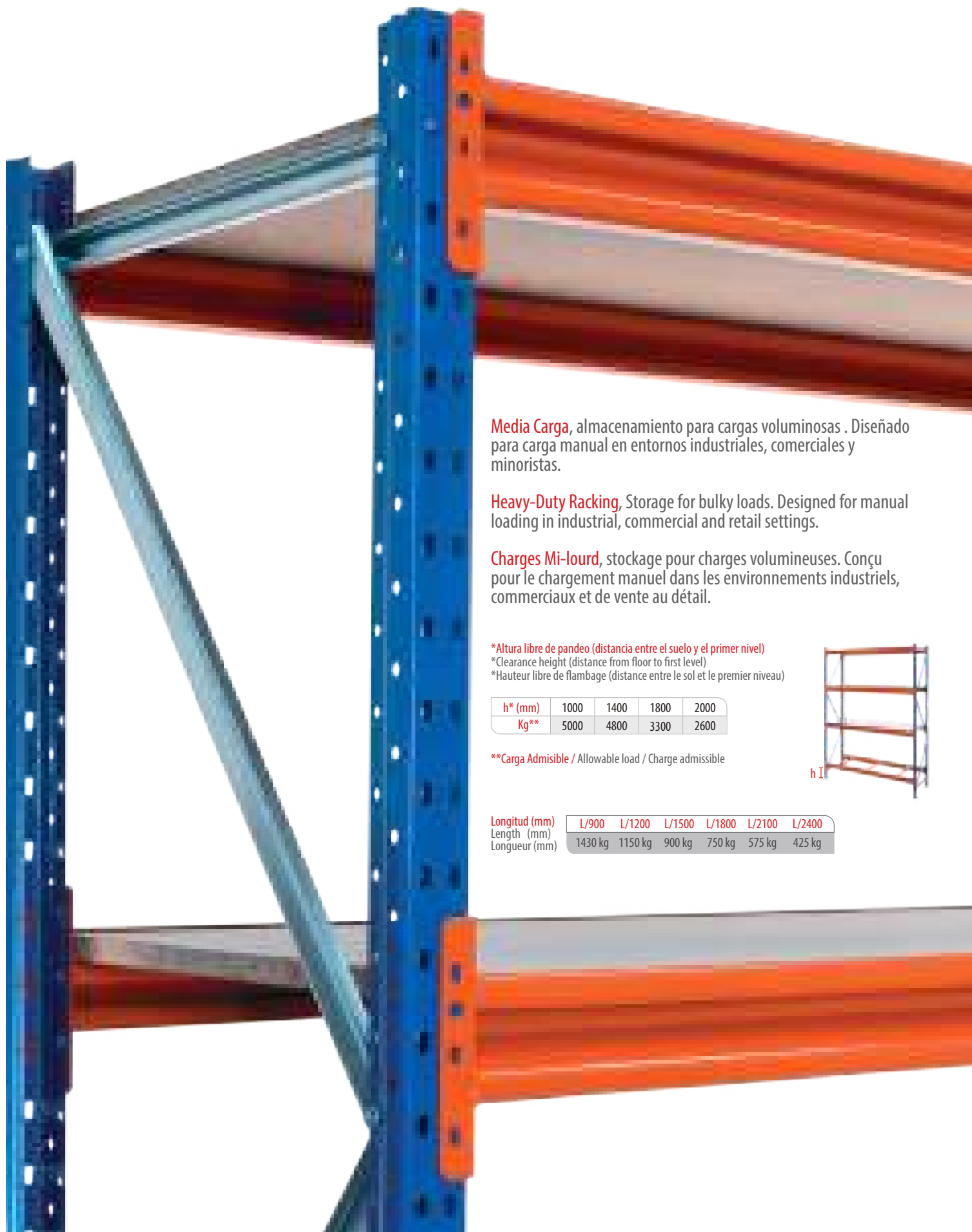

**Media Carga**, almacenamiento para cargas voluminosas . Diseñado para carga manual en entornos industriales, comerciales y minoristas.

**Heavy-Duty Racking**, Storage for bulky loads. Designed for manual loading in industrial, commercial and retail settings.

**Charges Mi-lourd**, stockage pour charges volumineuses. Conçu pour le chargement manuel dans les environnements industriels, commerciaux et de vente au détail.

\***Altura libre de pandeo (distancia entre el suelo y el primer nivel)**  
 \*Clearance height (distance from floor to first level)  
 \*Hauteur libre de flambage (distance entre le sol et le premier niveau)

<b>h* (mm)</b>	1000	1400	1800	2000
<b>Kg**</b>	5000	4800	3300	2600

\*\***Carga Admisible / Allowable load / Charge admissible**

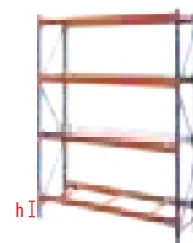

<b>Longitud (mm)</b>	<b>L/900</b>	<b>L/1200</b>	<b>L/1500</b>	<b>L/1800</b>	<b>L/2100</b>	<b>L/2400</b>
Length (mm)	1430 kg	1150 kg	900 kg	750 kg	575 kg	425 kg
Longueur (mm)						



**Bastidor** / Upright / Échelle

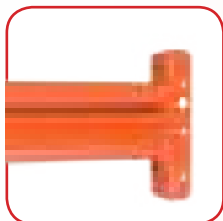

**Larguero** / Beam / Lisse



**Perno de seguridad**  
Safety pin  
Goupille de sécurité



**Pletina**  
Levelling  
Plaque de calage



**Anclaje** / Anchor / Ancrage



**Travesaño aglomerado**  
Chipboard cross member  
Traverse bois



**Aglomerado**  
Chipboard  
Aggloméré



**Balda galvanizada**  
Galvanised shelf  
Tablette galvanisée



**Unión bifrontal**  
Bi-frontal attachment  
Union d'échelle



**Unión a pared**  
Attachment to wall  
Fixation au mur

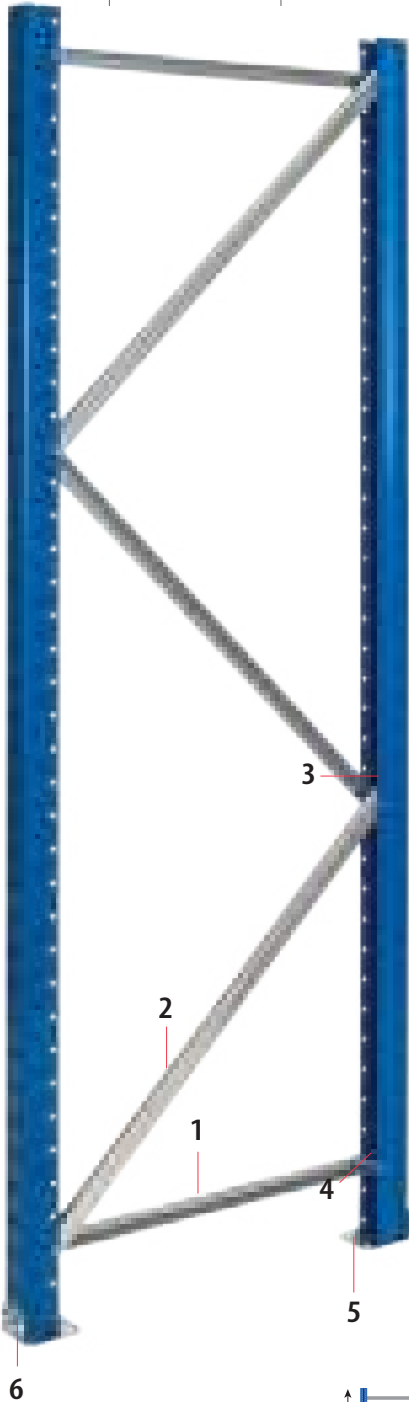
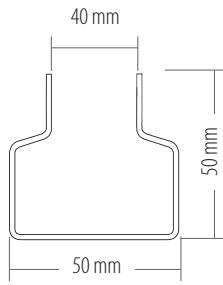

## Bastidor / Upright / Échelle

Artículo HxD Item HxD Article HxP	Referencia Reference Référence	€/Unidad €/Unit €/Unité	Cod. EAN EAN Code Code EAN	Peso kg Weight kg Poids kg	Uds. Paquete Units package Unités par paquet
2000 x 400	59032004	53,27	8431206590033	8,80	1
2000 x 500	59032005	54,36	8431206590149	9,00	1
2000 x 600	59032006	55,46	8431206590255	9,20	1
2000 x 800	59032008	58,23	8431206590361	9,60	1
2000 x 1000	59032010	61,07	8431206590477	10,00	1
2000 x 1200	59032012	62,52	8431206590583	10,50	1
2500 x 400	59032504	60,91	8431206590040	10,60	1
2500 x 500	59032505	61,95	8431206590156	10,80	1
2500 x 600	59032506	62,99	8431206590262	11,00	1
2500 x 800	59032508	65,96	8431206590378	11,40	1
2500 x 1000	59032510	69,67	8431206590484	11,90	1
2500 x 1200	59032512	70,94	8431206590590	12,40	1
3000 x 400	59033004	73,33	8431206590057	12,80	1
3000 x 500	59033005	74,75	8431206590163	13,00	1
3000 x 600	59033006	76,17	8431206590279	13,30	1
3000 x 800	59033008	80,11	8431206590385	13,80	1
3000 x 1000	59033010	83,07	8431206590491	14,30	1
3000 x 1200	59033012	84,48	8431206590606	14,90	1

RAL 5156 Azul / Blue / Bleu

Galvanizado / Galvanized / Galvanisée

## Componentes Bastidor / Upright components / Composants d'échelle

Altura Height Hauteur	Horizontales <sup>1</sup> Horizontal Horizontale	Diagonales <sup>2</sup> Diagonal Diagonale	Tornillo M6x40 <sup>3</sup> Screw M6x40 Vis M6x40	Casquillo <sup>4</sup> bushing douille	Pié Metálico <sup>5</sup> Metal foot Pied métallique	Tornillo M8x20 <sup>6</sup> Screw M8x20 Vis M8x20
1000	3	1	6	4	2	4
1500	2	2	5	2	2	4
2000	2	3	6	2	2	4
2500	3	3	8	4	2	4
3000	3	4	9	4	2	4

## Medidas de las Digonales y horizontales

Horizontal and diagonal measurements / Mesures horizontales et diagonales

	400	500	600	800	1000	1200
Profundidad / Depth / Profondeur	400	500	600	800	1000	1200
Horizontales / Horizontal / Horizontale	348	448	548	748	948	1148
Diagonales / Diagonal / Diagonale	713	765	825	968	1125	1303

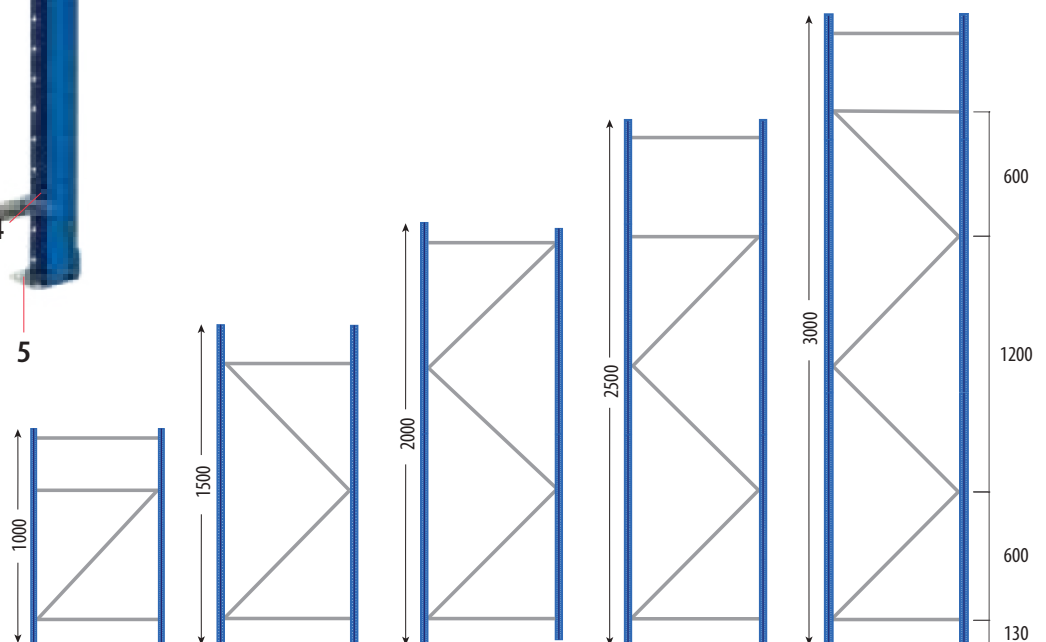



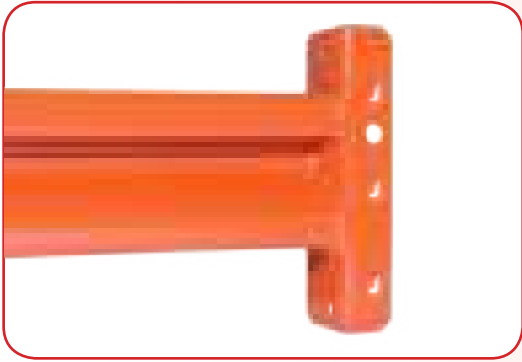

## Largueros / Beams / Lisses

Artículo L Item L Article L	Referencia Référence	€/ Unidad €/ Unité	Cod. EAN EAN Code Code EAN	Peso kg Weight kg Poids kg	Uds. Paquete Units package Unités paquet
Z80 x 30 / 900	59048409	15,15	8431206590677	2,00	2
Z80 x 30 / 1200	59048412	16,79	8431206590682	2,51	2
Z80 x 30 / 1500	59048415	17,79	8431206590699	3,02	2
Z80 x 30 / 1800	59048418	20,78	8431206590705	3,53	2
Z80 x 30 / 2100	59048421	23,19	8431206590712	4,04	2
Z80 x 30 / 2400	59048424	26,76	8431206590729	4,55	2

RAL 2154 Naranja / Orange / Orange 

## Accesorios / Accessories / Accessoires

Artículo Item Article	Referencia Référence	€/ Unidad €/ Unité	Cod. EAN EAN Code Code EAN	Peso kg Weight kg Poids kg	Uds. Paquete Units package Unités paquet
Perno de seguridad / Larguero Safety pin / Beam Goupille de sécurité / Lisse	59000001	0,20	8431206591016	0,01	2
Pletina de nivelación 1,5 mm Levelling plate 1,5 mm Plaques de calage 1,5 mm	59000008	1,00	8431206591023	0,05	2
M6 x 60/9 anclaje / Suelo M6 x 60/9 Anchor / Floor Ancrage M6 x 60/9 / Sol	59000034	0,48	8431206591030	0,02	2

Galvanizado / Galvanized / Galvanisée 

Tornillería incluida / Screws included / Vis incluses

2uds.



Tornillería incluida / Screws included / Vis incluses

4uds.

## Uniones / Attachment / Unions

Artículo Item Article	Referencia Référence	€/ Unidad €/ Unité	Cod. EAN EAN Code Code EAN	Peso kg Weight kg Poids kg	Uds. Paquete Units package Unités paquet
Unión a pared 100 mm Attachment to wall 100 mm Fixation au mur 100 mm	59090036	3,83	8431206591047	0,24	1
Unión a pared 200 mm Attachment to wall 200 mm Fixation au mur 200 mm	59090038	4,13	8431206591061	0,38	1
Unión a pared 300 mm Attachment to wall 300 mm Fixation au mur 300 mm	59090040	4,43	8431206591085	0,52	1
Unión bifrontal 100 mm Bi-frontal attachment 100 mm Union bifrontale 100 mm	59090046	3,95	8431206591160	0,27	1
Unión bifrontal 200 mm Bi-frontal attachment 200 mm Union bifrontale 200 mm	59090047	4,25	8431206591177	0,41	1
Unión bifrontal 300 mm Bi-frontal attachment 300 mm Union bifrontale 300 mm	59090048	4,55	8431206591184	0,55	1

Galvanizado / Galvanized / Galvanisée 

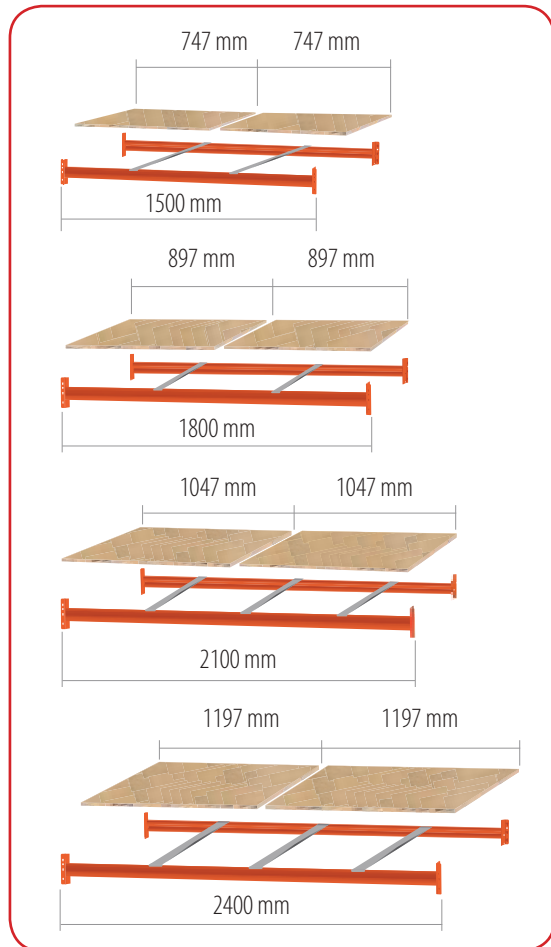
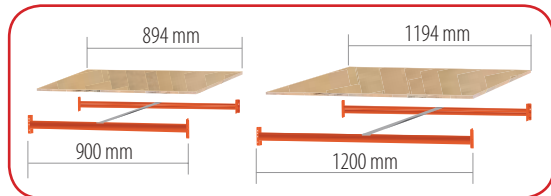
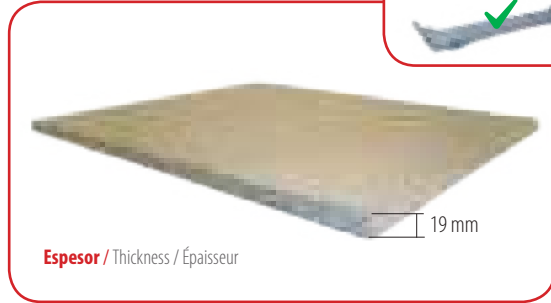
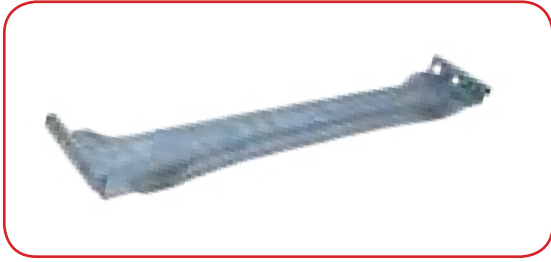

## Travesaños / Cross members / Traverses

Artículo L Item L Article L	Referencia Reference Référence	€/Unidad €/Unit €/Unité	Cod. EAN EAN Code Code EAN	Peso kg Weight kg Poids kg	Uds. Paquete Units Package Unités paquet
400	59090055	5,59	8431206590835	0,40	1
500	59090056	6,22	8431206590842	0,48	1
600	59090057	6,85	8431206590859	0,56	1
800	59090058	8,11	8431206590866	0,72	1
1000	59090059	9,37	8431206590873	0,88	1
1200	59090060	10,63	8431206590880	1,04	1

**Galvanizado / Galvanized / Galvanisée**

## Aglomerado 1 pieza / Chipboard 1 item / Aggloméré 1 pièce

Para niveles con travesaño / For shelves with cross members / Pour étagères avec traverse

Artículo LxP Item LxD Article LxP	Referencia Reference Référence	€/Unidad €/Unit €/Unité	Cod. EAN EAN Code Code EAN	Peso kg Weight kg Poids kg	Uds. Paquete Units Package Unités par paquet
894 x 385	59089038	8,84	8431206596011	4,03	1
894 x 485	59089048	11,35	8431206596035	5,10	1
894 x 585	59089058	13,22	8431206596059	6,17	1
894 x 785	59089078	17,63	8431206596073	8,30	1
894 x 985	59089098	22,06	8431206596097	10,44	1
894 x 1185	59089118	26,47	8431206596110	12,57	1
1194 x 385	59119038	11,79	8431206596134	5,46	1
1194 x 485	59119048	14,69	8431206596158	6,88	1
1194 x 585	59119058	17,63	8431206596172	8,30	1
1194 x 785	59119078	23,53	8431206596196	11,15	1
1194 x 985	59119098	29,43	8431206596219	13,99	1
1194 x 1185	59119118	35,32	8431206596233	16,72	1

## Aglomerado 2 piezas / Chipboard 2 items / Aggloméré 2 pièces

Para niveles con travesaño /

Artículo LxP Item LxD Article LxP	Referencia Reference Référence	€/Unidad €/Unit €/Unité	Cod. EAN EAN Code Code EAN	Peso kg Weight kg Poids kg	Uds. Paquete Units Package Unités par paquet
747 + 747 x 385	59149038	15,17	8431206596257	6,88	1 + 1
747 + 747 x 485	59149048	18,98	8431206596271	8,54	1 + 1
747 + 747 x 585	59149058	22,41	8431206596295	10,32	1 + 1
747 + 747 x 785	59149078	30,38	8431206596318	13,88	1 + 1
747 + 747 x 985	59149098	37,96	8431206596332	17,43	1 + 1
747 + 747 x 1185	59149118	44,12	8431206596356	20,99	1 + 1
897 + 897 x 385	59179038	17,63	8431206596370	8,18	1 + 1
897 + 897 x 485	59179048	22,67	8431206596394	10,32	1 + 1
897 + 897 x 585	59179058	26,47	8431206596417	12,45	1 + 1
897 + 897 x 785	59179078	35,28	8431206596431	16,72	1 + 1
897 + 897 x 985	59179098	44,12	8431206596455	20,99	1 + 1
897 + 897 x 1185	59179118	52,91	8431206596479	25,26	1 + 1
1047 + 1047 x 385	59209038	21,71	8431206596493	9,61	1 + 1
1047 + 1047 x 485	59209048	25,31	8431206596516	12,10	1 + 1
1047 + 1047 x 585	59209058	30,38	8431206596530	14,47	1 + 1
1047 + 1047 x 785	59209078	40,47	8431206596554	19,45	1 + 1
1047 + 1047 x 985	59209098	50,61	8431206596578	24,43	1 + 1
1047 + 1047 x 1185	59209118	60,75	8431206596592	29,41	1 + 1
1197 + 1197 x 385	59239038	23,53	8431206596615	10,91	1 + 1
1197 + 1197 x 485	59239048	35,32	8431206596639	13,76	1 + 1
1197 + 1197 x 585	59239058	35,32	8431206596653	16,60	1 + 1
1197 + 1197 x 785	59239078	47,06	8431206596677	22,30	1 + 1
1197 + 1197 x 985	59239098	70,59	8431206596691	27,99	1 + 1
1197 + 1197 x 1185	59239118	70,59	8431206596714	33,68	1 + 1

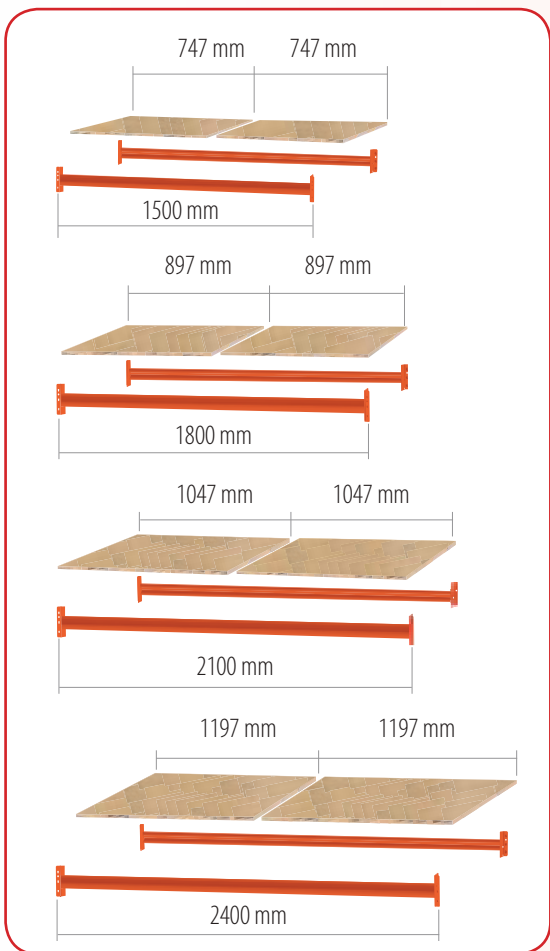
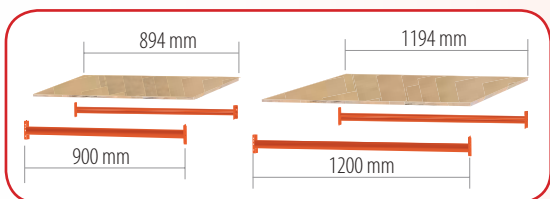
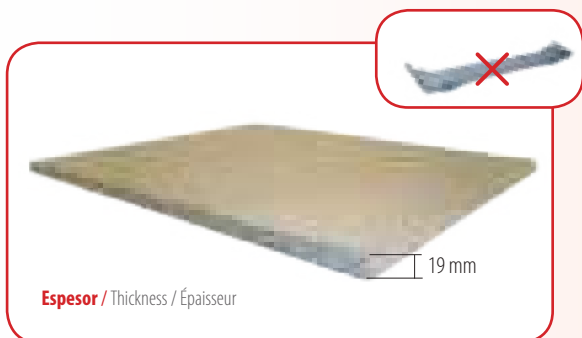

## Aglomerado 1 pieza / Chipboard 1 item / Aggloméré 1 pièce

Para niveles sin travesaño /

Artículo LxP Item LxD Article LxP	Referencia Reference Référence	€/Unidad €/Unit €/Unité	Cod. EAN EAN Code Code EAN	Peso kg Weight kg Poids kg	Uds. Paquete Units Package Unités par paquet
894 x 395	59089039	8,84	8431206596028	4,15	1
894 x 495	59089049	11,35	8431206596042	5,22	1
894 x 595	59089059	13,22	8431206596066	6,29	1
894 x 795	59089079	17,63	8431206596080	8,42	1
894 x 995	59089099	22,06	8431206596103	10,56	1
894 x 1195	59089119	26,47	8431206596127	12,69	1
1194 x 395	59119039	11,79	8431206596141	5,57	1
1194 x 495	59119049	14,69	8431206596165	7,00	1
1194 x 595	59119059	17,63	8431206596189	8,42	1
1194 x 795	59119079	23,53	8431206596202	11,27	1
1194 x 995	59119099	29,43	8431206596226	14,11	1
1194 x 1195	59119119	35,32	8431206596240	16,96	1

## Aglomerado 2 piezas / Chipboard 2 items / Aggloméré 2 pièces

Para niveles sin travesaño /

Artículo LxP Item LxD Article LxP	Referencia Reference Référence	€/Unidad €/Unit €/Unité	Cod. EAN EAN Code Code EAN	Peso kg Weight kg Poids kg	Uds. Paquete Units Package Unités par paquet
747 + 747 x 395	59149039	15,17	8431206596264	7,00	1 + 1
747 + 747 x 495	59149049	18,98	8431206596288	8,78	1 + 1
747 + 747 x 595	59149059	22,41	8431206596301	10,56	1 + 1
747 + 747 x 795	59149079	30,38	8431206596325	14,11	1 + 1
747 + 747 x 995	59149099	37,96	8431206596349	17,67	1 + 1
747 + 747 x 1195	59149119	44,12	8431206596363	21,23	1 + 1
897 + 897 x 395	59179039	17,63	8431206596387	8,42	1 + 1
897 + 897 x 495	59179049	22,67	8431206596400	10,56	1 + 1
897 + 897 x 595	59179059	26,47	8431206596424	12,69	1 + 1
897 + 897 x 795	59179079	35,28	8431206596448	16,96	1 + 1
897 + 897 x 995	59179099	44,12	8431206596462	21,23	1 + 1
897 + 897 x 1195	59179119	52,91	8431206596486	25,38	1 + 1
1047 + 1047 x 395	59209039	21,71	8431206596509	9,84	1 + 1
1047 + 1047 x 495	59209049	25,31	8431206596523	12,33	1 + 1
1047 + 1047 x 595	59209059	30,38	8431206596547	14,83	1 + 1
1047 + 1047 x 795	59209079	40,47	8431206596561	19,69	1 + 1
1047 + 1047 x 995	59209099	50,61	8431206596585	24,67	1 + 1
1047 + 1047 x 1195	59209119	60,75	8431206596608	29,65	1 + 1
1197 + 1197 x 395	59239039	23,53	8431206596622	11,27	1 + 1
1197 + 1197 x 495	59239049	35,32	8431206596646	14,11	1 + 1
1197 + 1197 x 595	59239059	35,32	8431206596660	16,84	1 + 1
1197 + 1197 x 795	59239079	47,06	8431206596684	22,53	1 + 1
1197 + 1197 x 995	59239099	70,59	8431206596707	28,23	1 + 1
1197 + 1197 x 1195	59239119	70,59	8431206596721	33,92	1 + 1

## Baldas / Shelves / Tablettes

Artículo L Item L Article L	Referencia Reference Référence	€/Unidad €/Unit €/Unité	Cod. EAN EAN Code Code EAN	Peso kg Weight kg Poids kg	Uds. Paquete Units package Unités paquet
400 x 300	59090403	6,44	8431206590958	0,67	10
500 x 300	59090503	7,31	8431206590965	0,84	10
600 x 300	59090603	8,18	8431206590972	1,01	10
800 x 300	59090803	9,94	8431206590989	1,35	10
1000 x 300	59091003	11,70	8431206590996	1,69	10
1200 x 300	59091203	13,46	8431206591009	2,03	10

Galvanizado / Galvanized / Galvanisée



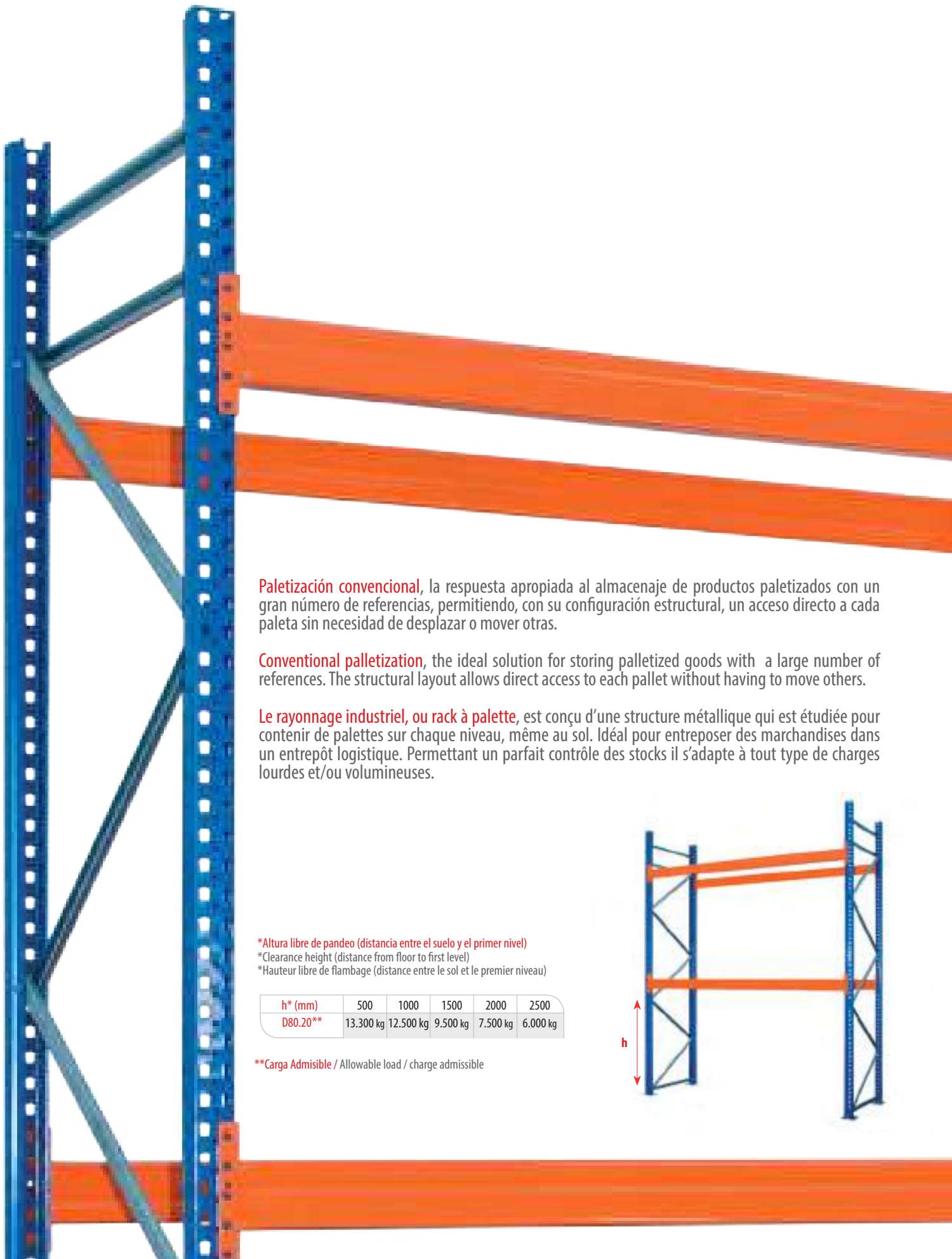

**Paletización convencional**, la respuesta apropiada al almacenaje de productos paletizados con un gran número de referencias, permitiendo, con su configuración estructural, un acceso directo a cada paleta sin necesidad de desplazar o mover otras.

**Conventional palletization**, the ideal solution for storing palletized goods with a large number of references. The structural layout allows direct access to each pallet without having to move others.

**Le rayonnage industriel, ou rack à palette**, est conçu d'une structure métallique qui est étudiée pour contenir de palettes sur chaque niveau, même au sol. Idéal pour entreposer des marchandises dans un entrepôt logistique. Permettant un parfait contrôle des stocks il s'adapte à tout type de charges lourdes et/ou volumineuses.

\*Altura libre de pandeo (distancia entre el suelo y el primer nivel)

\*Clearance height (distance from floor to first level)

\*Hauteur libre de flambage (distance entre le sol et le premier niveau)

h* (mm)	500	1000	1500	2000	2500
D80.20**	13.300 kg	12.500 kg	9.500 kg	7.500 kg	6.000 kg

\*\*Carga Admisible / Allowable load / charge admissible

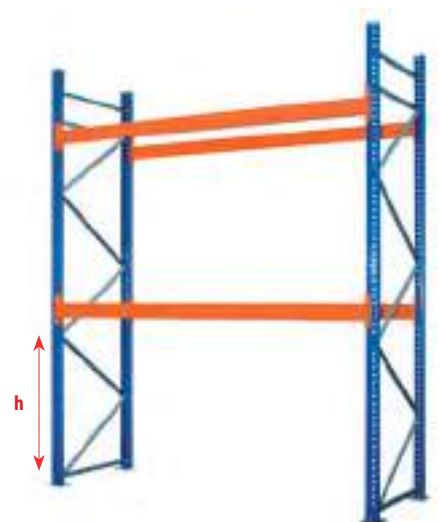



**Bastidor** / Upright / Échelle



**Larguero** / Beam / Lisse



**Perno de seguridad**  
Safety pin  
Goupille de sécurité



**Pletina**  
Levelling / Plaque de calage



**Anclaje** / Anchor / Ancrage



**Unión bifrontal**  
Bi-frontal attachment  
Union d'échelle



**Travesaño exterior aglomerado**  
External chipboard cross member  
Traverse bois



**Travesaño interior paleta**  
Internal palletcross member  
Traverse palette



**Protección bastidor**  
Upright protection  
Protection échelle



**Protección lateral**  
Side protection  
Protection latérale



**Anclaje protector bastidor**  
Anchor protector upright  
Ancrage protection échelle

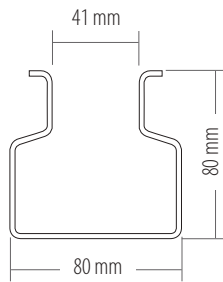

## Bastidor D80.20 / D80.20 Upright / Échelle D80.20

Artículo HxD Item HxD Article HxP	Referencia Reference Référence	€/ Unidad € / Unit €/ Unité	Cod. EAN EAN Code Code EAN	Peso kg Weight kg Poids kg	Uds. Paquete Units package Unités par paquet
2000 x 1050	77021121	116,04	8431206771210	24,56	1
2500 x 1050	77021122	137,52	8431206771227	29,84	1
3000 x 1050	77021124	159,39	8431206771241	35,03	1
3500 x 1050*	77021126	180,84	8431206771265	40,31	1
4000 x 1050*	77021127	196,56	8431206771272	44,49	1
4500 x 1050*	77021129	218,01	8431206771296	49,77	1
5000 x 1050*	77021131	245,31	8431206771319	55,06	1
5500 x 1050*	77021132	266,82	8431206771326	60,34	1
6000 x 1050*	77021134	288,66	8431206771340	65,53	1

RAL 5010 azul / Blue / Bleu

Galvanizado / Galvanized / Galvanisée

Bastidores en fondo 700 y 850, consultar  
Uprights with 700 and 850 depth, please consult / Échelle profondeur 700 et 850 à consulter

## Componentes Bastidor / Upright components / Composants d'échelle

Altura Height Hauteur	Horizontales <sup>1</sup> Horizontal Horizontale	Diagonales <sup>2</sup> Diagonal Diagonale	Tornillo M10x60 <sup>3</sup> Screw M10x60 Vis M10x60	Casquillo <sup>4/5</sup> bushing douille	Pie Metálico <sup>6</sup> Metal foot Pied métallique	Tornillo M10x20 <sup>7</sup> Screw M10x20 Vis M10x20
2000	2	3	8	2 2	2	2
2500	2	4	9	2 2	2	2
3000	3	4	11	2 4	2	2
3500	3	5	12	2 4	2	2
4000	2	6	11	2 2	2	2
4500	2	7	12	2 2	2	2
5000	2	8	13	2 2	2	2
5500	2	9	14	2 2	2	2
6000	3	9	16	2 4	2	2

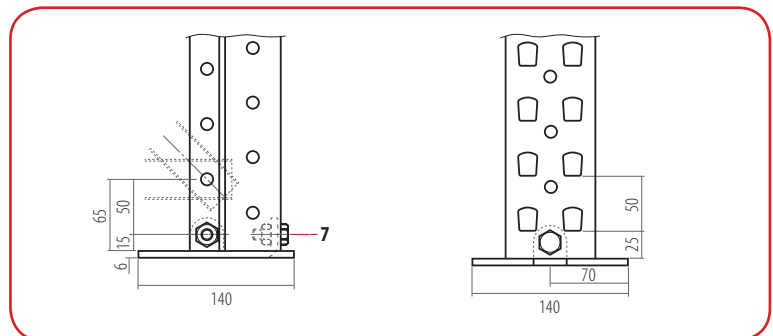
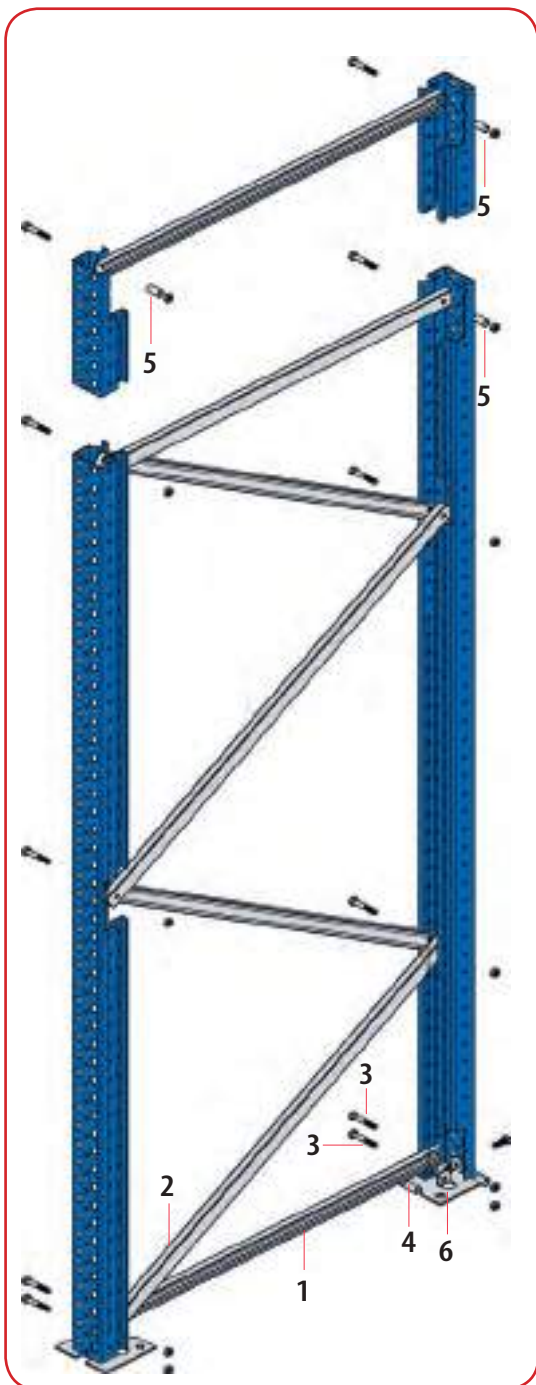

- 1 Horizontal / Horizontal / Horizontale
- 2 Diagonal / Diagonal / Diagonale
- 3 Tornillo M10 x 60 DIN-933.8.8 / Bolt / Boulon  
Tuerca M10 DIN-985.8 / Nut / Écrou

- 4 Casquillo Ø 16/13 L= 28 mm / bushing / douille
- 5 Casquillo Ø 16/13 L= 38 mm / bushing / douille
- 6 Pie metálico / Footplate / Pied métallique
- 7 Tornillo M10 x 20 DIN-933.8.8 / Bolt / Boulon  
Tuerca M10 DIN-934.8 / Nut / Écrou

\*En bastidores y largueros con longitud superior a 3 metros se aplicará un suplemento de transporte del 6% sobre tarifa base, con un mínimo de 50€.  
\*In uprights and beams with a length greater than 3 meters, a transport supplement of 6% will be applied on the base rate, with a minimum of € 50.  
\* Dans les échelles et lisses d'une longueur supérieure à 3 mètres, un supplément transport de 6% sera appliqué sur le tarif de base, avec un minimum de 50 €.



## Larguero CC2 / CC2 beam / Lisse CC2

Artículo L Item L Article L	Referencia Reference Référence	€/ Unidad €/ Unit €/ Unité	Cod. EAN EAN Code Code EAN	Peso kg Weight kg Poids kg	Uds. Paquete Units package Unités paquet
CC2 80 / 1825	77010029	43,59	8431206770299	9,35	2
CC2 100 / 1825	77010104	46,83	8431206771043	10,20	2
CC2 80 / 2225	77010030	50,16	8431206770305	11,06	2
CC2 100 / 2225	77010105	54,09	8431206771050	12,11	2
CC2 80 / 2700	77010031	58,86	8431206770312	13,10	2
CC2 100 / 2700	77010106	63,66	8431206771067	14,37	2
CC2 120 / 2700	77010256	68,58	8431206772569	15,63	2
CC2 145 / 2700	77010257	77,46	8431206772576	17,22	2
CC2 145 / 3300	77010258	90,81	8431206772583	20,71	2
CC2 160 / 3600	77010259	98,07	8431206772590	23,57	2

RAL 2004 Naranja / Orange / Orange 

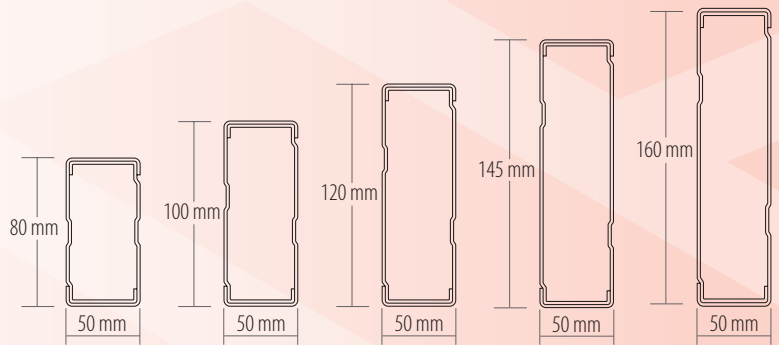
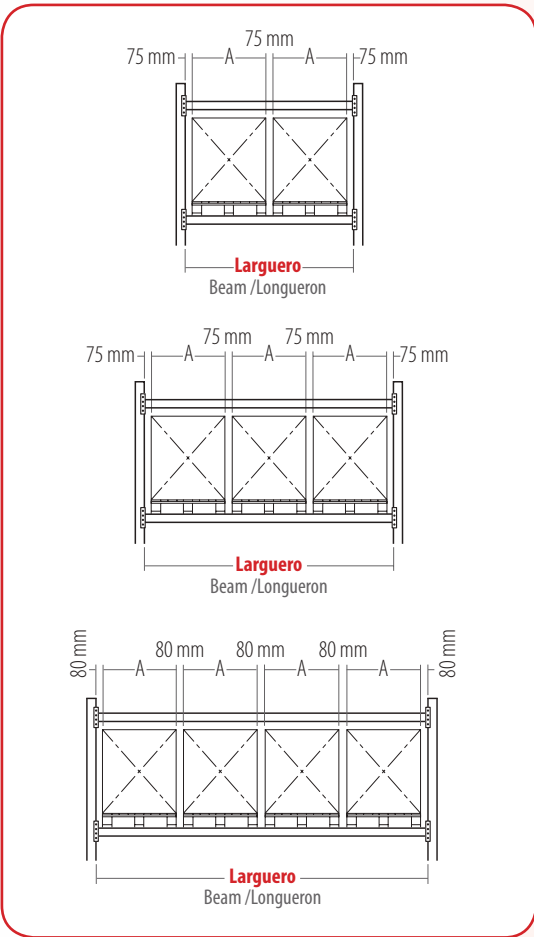

Larguero Beam Lisse	L / 1825	L / 2225	L / 2700	L / 3300	L / 3600
CC2 80	2600 kg	2200 kg	1900 kg	-	-
CC2 100	3200 kg	3000 kg	2500 kg	-	-
CC2 120	-	-	2900 kg	-	-
CC2 145	-	-	3900 kg	3300 kg	-
CC2 160	-	-	-	-	3400 kg

Capacidad de carga por par de largueros / Load capacity per pair of beams / Capacité de charge par couple de longuerons

Nº de paletas No. of pallets Nº de palettes	Paleta Palet / Palette (A) 800 x 1200	Paleta Palet / Palette (A) 1000 x 1200	Paleta Palet / Palette (A) 1200 x 1200
2	(L) 1825	(L) 2225	(L) 2700
3	(L) 2700	(L) 3300	-
4	(L) 3600	-	-

(L) Longitud larguero / (L) Length of beam / (L) Longueur du longueron

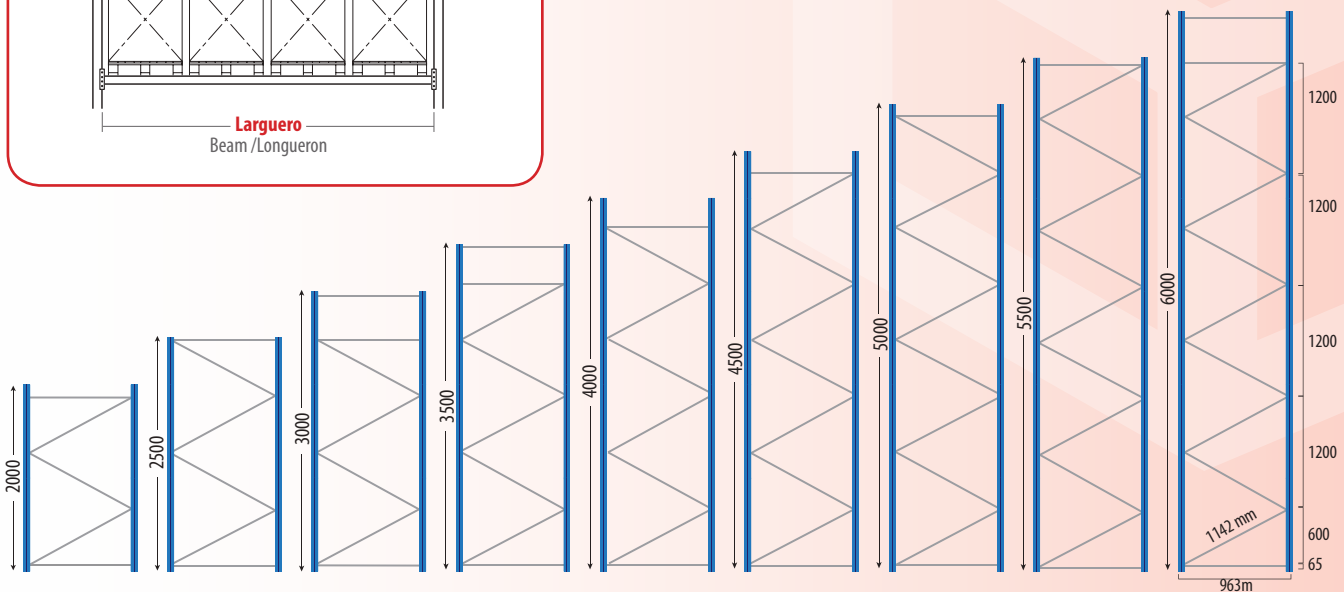

Instrucciones de montaje / Assembly instructions / Instructions d'assemblage



**Perno de seguridad** / Safety pin / Goupille de sécurité



**Pletina de nivelación** / Levelling plate / Plaques de calage



**Anclaje M10 x 70** / Anchor M10 x 70 / Ancre M10 x 70



**Anclajes no incluidos**  
Anchors not included  
Ancrages non inclus

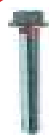

**Tornillería incluida**  
Screws included  
Vis incluses



## Accesorios / Accessories / Accessoires

Artículo Item Article	Referencia Reference Référence	€/Unidad €/Unit €/Unité	Cod. EAN EAN Code Code EAN	Peso kg Weight kg Poids kg	Uds. Paquete Units package Unités paquet
Perno de seguridad / Larguero Safety pin / Beam Goupille de sécurité / Lisse	77000001	0,48	8431206770015	0,01	2
Pletina de nivelación 1,5 mm Levelling plate 1,5 mm Plaques de calage 1,5 mm	77000008	1,73	8431206770084	0,21	2
Anclaje M10 x 70/14 / Suelo Anchor M10 x 70/14 / Floor Ancre M10 x 70/14 / Sol	77000032	1,04	8431206770329	0,07	4

**Galvanizado** / Galvanized / Galvanisée



## Protecciones y anclaje / Protections ans ancrors / Protections et ancrage

Artículo Item Article	Referencia Reference Référence	€/Unidad €/Unit €/Unité	Cod. EAN EAN Code Code EAN	Peso kg Weight kg Poids kg	Uds. Paquete Units package Unités paquet
Protección bastidor Upright protection Protection échelle	77000033	59,40	8431206770336	8,39	1
Protección lateral 1150 mm Side protection 1150 mm Protection latérale 1150 mm	77000034	41,25	8431206770343	6,18	1
Protección lateral 2500 mm Side protection 2500 mm Protection latérale 2500 mm	77000035	132,68	8431206770350	19,48	1
Anclaje M16 x 110/20 / Protector Anchor M16 x 110/20 / Protector Ancre M16 x 110/20 / Protecteur	77000036	3,52	8431206770367	0,27	4

**RAL 1003 amarillo** / Yellow / Jaune







Tornillería incluida / Screws included / Vis incluses



2uds.



Tornillería incluida / Screws included / Vis incluses



4uds.



Galvanizado / Galvanised / Galvanisée

Referencia / Reference / Référence: 77000053

**Uniones /** Attachment / Unions

Artículo Item Article	Referencia Reference Référence	€/Unidad €/Unit €/Unité	Cod. EAN EAN Code Code EAN	Peso kg Weight kg Poids kg	Uds. Paquete Units package Unités paquet
Unión a pared 100 mm Attachment to wall 100 mm Fixation au mur 100 mm	77000037	3,83	8431206770374	0,24	1
Unión a pared 200 mm Attachment to wall 200 mm Fixation au mur 200 mm	77000038	4,13	8431206770381	0,38	1
Unión a pared 300 mm Attachment to wall 300 mm Fixation au mur 300 mm	77000039	4,43	8431206770398	0,52	1
Unión bifrontal 300 mm Bi-frontal attachment 300 mm Union bifrontale 300 mm	77000048	4,55	8431206770480	0,55	1

Galvanizado / Galvanized / Galvanisée

**Travesaños /** Cross members / Traverses

Artículo Item Article	Referencia Reference Référence	€/Unidad €/Unit €/Unité	Cod. EAN EAN Code Code EAN	Peso kg Weight kg Poids kg	Uds. Paquete Units package Unités paquet
Travesaño exterior aglomerado 1050 mm External chipboard cross member 1050 mm Traverse extérieure bois 1050 mm	77000053	16,36	8431206770534	3,21	1
Travesaño interior paleta 1050 mm Internal pallet cross member 1050 mm Traverse intérieure palette 1050 mm	77000056	20,64	8431206770565	4,12	1



RAL 5010 azul / Blue / Bleu

Referencia / Reference / Référence: 77000056

**Aglomerado 1 pieza /** Chipboard 1 item / Aggloméré 1 pièce

Artículo LxP Item LxP Article LxP	Referencia Reference Référence	€/Unidad €/Unit €/Unité	Cod. EAN EAN Code Code EAN	Peso kg Weight kg Poids kg	Uds. Paquete Units Package Unités par paquet
1825 / 1805 x 1040	77180104	Consultar	-	33,52	1
2225 / 2205 x 1040	77220104	Consultar	-	40,83	1
2700 / 2680 x 1040	77268104	Consultar	-	49,75	1
3300 / 3280 x 1040	77328104	Consultar	-	60,80	1
3600 / 3580 x 1040	77358104	Consultar	-	66,33	1

# Sistema de inicial y extensiones

Start and add-on system / Système d'initial et extensions



*Una solución al equipamiento de vestuarios. Volúmenes modulares concebidos para armonizar con el entorno de su ubicación.*

*An ideal solution for equipping changing rooms. Modular units designed to blend in perfectly with their surroundings.*

*Une solution à l'équipement des vestiaires. Des volumes modulaires conçus pour s'harmoniser avec l'environnement de leur emplacement.*

**Colores estándar**  
Standard colours  
Couleurs standards

**Puerta**  
Door / Porte



**RAL 5014 Azul**  
Blue  
Bleu



**RAL 7035 Gris\***  
Grey  
Gris

\*Consultar disponibilidad

Check availability  
Voir les disponibilités

**Cuerpo**  
Body / Corps



**RAL 7035 Gris**  
Grey  
Gris



**Rosetas de ventilación\***  
Ventilation rosettes  
Rosaces de ventilation



**Balda Galvanizada\*\***  
Galvanized shelf  
Étagère galvanisée



**Etiquetero Identificador**  
Labeller Identifier  
Identifiant de l'étiqueteur



**Cerradura de Cilindro**  
Cylinder lock  
Serrure à cylindre

\*Los modelos CS5, CS6, CS8 y CS10 no llevan rosetas de ventilación \*\* Includida en los artículos AR250I, AR250E, AR300I, AR300E, AR400I y AR400E  
\*CS5, CS6, CS8 and CS10 models do not have ventilation rosettes \*\* Included in articles AR250I, AR250E, AR300I, AR300E, AR400I, AR400E  
\*Les modèles CS5, CS6, CS8 et CS10 n'ont pas de rosettes de ventilation \*\* Inclus dans les articles AR250I, AR250E, AR300I, AR300E, AR400I, AR400E

**Opciones / Options / Options**



**Techo inclinado**  
Sloping top  
Toit incliné

P. 68



**Patas de acero**  
Steel legs  
Pieds en acier

P. 68



**Zócalo / Base / Socle**

P. 68



**Cerraduras**  
Padlock  
Serrures

P. 69



**Divisor vertical**  
Vertical divider  
Séparateur vertical

P. 70



**Embellecedor lateral**  
Side trim  
Enjoliveur latéral

P. 71

**Colores opcionales**

Optional colours / Couleurs optionnelles



**RAL 2004 Naranja**  
Orange  
Orange



**RAL 3000 Rojo**  
Red  
Rouge



**RAL 5010 Azul**  
Blue  
Bleu



**RAL 6029 Verde**  
Green  
Vert



**RAL 9003 Blanco**  
White  
Blanc

**Otros colores consultar**

Other colors consult  
Autres couleurs consulter

Cambio de color Colour change Changement de couleur	Cantidad mínima para cambio de color, 24 unidades Minimum quantity for colour change: 24 units Quantité minimum pour changer de couleur, 24 unités
<b>Puerta</b> Door / Porte	<b>Incremento del 5% sobre el precio del artículo</b> 5% increase on article price Majoration de 5% sur le prix de l'article
<b>Cuerpo</b> Body / Corps	<b>Incremento del 10% sobre el precio del artículo</b> 10% increase on article price Majoration de 10% sur le prix de l'article
<b>Puerta y Cuerpo</b> Door and body / Porte et Corps	<b>Incremento del 15% sobre el precio del artículo</b> 15% increase on article price Majoration de 15% sur le prix de l'article

La familia "Mobiliario para vestuario y colectividades", la resistencia a la oxidación en los artículos de acero pintado, sólo se garantiza para ambientes secos.  
Para ambientes húmedos consultar con nuestro departamento comercial.

The "Furniture for changing rooms and community buildings", resistance to rusting of the painted steel articles is guaranteed for dry environments. For damp environments please consult with our sales department.  
Pour la famille "Mobiliario para vestuario y colectividades", la résistance à l'oxydation des articles en acier peint, n'est garantie qu'en environnements secs. Pour les environnements humides, prière de consulter notre département commercial.

Para pedidos a portes pagados se entiende por material desmontado, salvo que se haya acordado.  
Carriage paid orders are understood to refer to unmounted material, unless mounting has been agreed.  
Pour les commandes à ports payés, le matériel est entendu démonté, sauf accord.

Por razones técnicas de impresión, los colores pueden variar del catálogo con los de nuestros artículos.  
For technical printing reasons the colours indicated in the catalogue may differ from the actual article colours.  
Pour des raisons techniques d'impression, les couleurs de nos articles peuvent varier par rapport à celles du catalogue.

## Armario ropero / Lockers / Vestiaires

Artículo Item Article	Referencia Reference Référence	€/ Unidad €/ Unit €/ Unité	Cod. EAN EAN Code Code EAN	Peso k Weight k Poids k	Ancho Width Largueur
AR1/250I	6902501I	114,80	8431206691013	20,45	280
AR1/250E	6902501E	94,22	8431206691020	14,59	250
AR1/300I	6903001I	123,23	8431206691112	21,88	330
AR1/300E	6903001E	102,65	8431206691129	16,01	300
AR1/400I	6904001I	135,58	8431206691211	24,73	430
AR1/400E	6904001E	115,00	8431206691228	18,87	400

**Artículo AR300I, AR300E, AR400I y AR400E (Opcional divisor vertical)**  
 Item AR300I, AR300E, AR400I and AR400E (Optional vertical divider)  
 Article AR300I, AR300E, AR400I et AR400E (Séparateur vertical optionnel)

## Armario ropero grupos / Groups locker / Vestiaire groupes

Artículo Item Article	Referencia Reference Référence	€/ Unidad €/ Unit €/ Unité	Montaje € / Neto Assembly € / Net Montage € / Net	Cod. EAN EAN Code Code EAN	Peso k Weight k Poids k	Volúmen Volume Volume
AR1/251	69002511	114,80	4,25	8431206691037	20,45	0,26
AR1/252	69002521	209,02	8,50	8431206691044	35,04	0,50
AR1/253	69002531	303,24	12,75	8431206691051	49,63	0,73
AR1/254	69002541	397,46	17,00	8431206691068	64,22	0,96
AR1/301	69003011	123,23	4,25	8431206691136	21,88	0,31
AR1/302	69003021	225,88	8,50	8431206691143	37,89	0,59
AR1/303	69003031	328,53	12,75	8431206691150	53,90	0,87
AR1/304	69003041	431,18	17,00	8431206691167	69,91	1,15
AR1/401	69004011	135,58	4,25	8431206691235	24,73	0,40
AR1/402	69004021	250,58	8,50	8431206691242	43,60	0,78
AR1/403	69004031	365,58	12,75	8431206691259	62,47	1,15



## Taquillas / Lockers / Vestiaires

Artículo Item Article	Referencia Reference Référence	€/Unidad €/Unit €/Unité	Cod. EAN EAN Code Code EAN	Peso k Weight k Poids k	Ancho Width Largueur
TQ2/250I	6902502I	122,57	8431206692010	21,36	280
TQ2/250E	6902502E	101,99	8431206692027	15,49	250
TQ2/300I	6903002I	131,62	8431206692119	22,96	330
TQ2/300E	6903002E	111,04	8431206692126	17,10	300
TQ2/400I	6904002I	144,58	8431206692218	26,18	430
TQ2/400E	6904002E	124,00	8431206692225	20,32	400

## Taquilla grupos / Group lockers / Vestiaire groupes

Artículo Item Article	Referencia Reference Référence	€/Unidad €/Unit €/Unité	Montaje € / Neto Assembly € / Net Montage € / Net	Cod. EAN EAN Code Code EAN	Peso k Weight k Poids k	Volúmen Volume Volume
TQ2/251	69002512	122,57	5,00	8431206692034	21,36	0,26
TQ2/252	69002522	224,56	10,00	8431206692041	36,85	0,50
TQ2/253	69002532	326,55	15,00	8431206692058	52,34	0,73
TQ2/254	69002542	428,54	20,00	8431206692065	67,83	0,96
TQ2/301	69003012	131,62	5,00	8431206692133	22,96	0,31
TQ2/302	69003022	242,66	10,00	8431206692140	40,06	0,59
TQ2/303	69003032	353,70	15,00	8431206692157	57,16	0,87
TQ2/304	69003042	464,74	20,00	8431206692164	74,26	1,15
TQ2/401	69004012	144,58	5,00	8431206692232	26,18	0,40
TQ2/402	69004022	268,58	10,00	8431206692249	46,50	0,78
TQ2/403	69004032	392,58	15,00	8431206692256	66,82	1,15

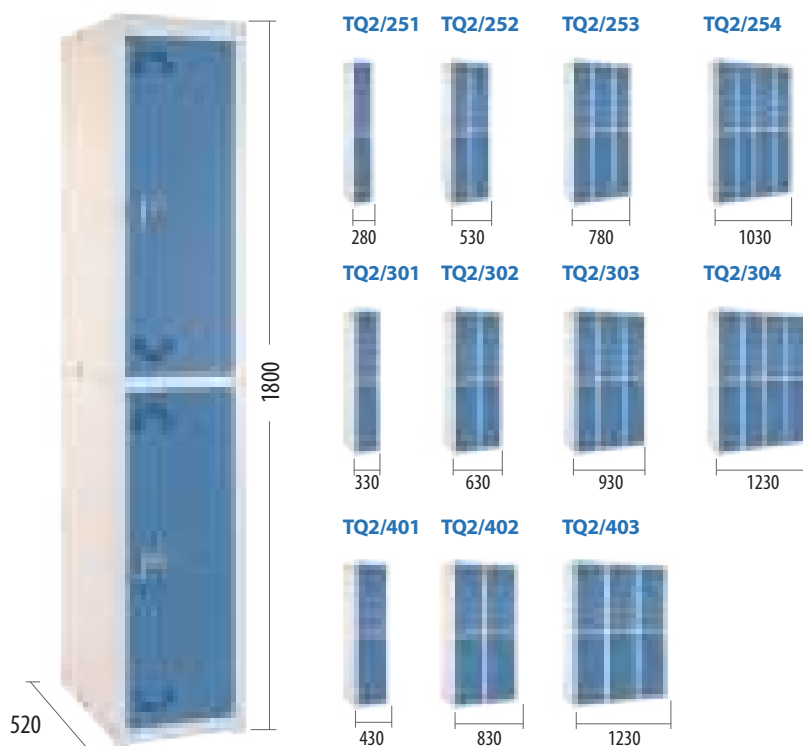

# Sistema de inicial y extensiones

Start and add-on system / Système d'initial et extensions



## Consignas / Lockers / Consignes

Artículo Item Article	Referencia Reference Référence	€/ Unidad €/ Unit €/ Unité	Cod. EAN EAN Code Code EAN	Peso k Weight k Poids k	Ancho Width Largeur
CS3/250I	6902503I	137,57	8431206693017	22,14	280
CS3/250E	6902503E	115,85	8431206693024	16,28	250
CS3/300I	6903003I	147,77	8431206693116	23,85	330
CS3/300E	6903003E	126,05	8431206693123	17,99	300
CS3/400I	6904003I	165,53	8431206693215	27,27	430
CS3/400E	6904003E	143,36	8431206693222	21,40	400

## Consigna grupos / Group lockers / Consigne groupes

Artículo Item Article	Referencia Reference Référence	€/ Unidad €/ Unit €/ Unité	Montaje € / Neto Assembly € / Net Montage € / Net	Cod. EAN EAN Code Code EAN	Peso k Weight k Poids k	Volúmen Volume Volume
CS3/251	69002513	137,57	5,75	8931206693031	22,14	0,26
CS3/252	69002523	253,42	11,50	8931206693048	38,42	0,50
CS3/253	69002533	369,27	17,25	8931206693055	54,70	0,73
CS3/254	69002543	485,12	23,00	8931206693062	70,98	0,96
CS3/301	69003013	147,77	5,75	8931206693130	23,85	0,31
CS3/302	69003023	273,82	11,50	8931206693147	41,84	0,59
CS3/303	69003033	399,87	17,25	8931206693154	59,83	0,87
CS3/304	69003043	525,92	23,00	8931206693161	77,82	1,15
CS3/401	69004013	165,53	5,75	8931206693239	27,27	0,40
CS3/402	69004023	308,89	11,50	8931206693246	48,67	0,78
CS3/403	69004033	452,25	17,25	8931206693253	70,07	1,15



## Consignas / lockers / Consignes

Artículo Item Article	Referencia Reference Référence	€/Unidad €/Unit €/Unité	Cod. EAN EAN Code Code EAN	Peso k Weight k Poids k	Ancho Width Largueur
CS4/250I	6902504I	148,84	8431206694014	23,28	280
CS4/250E	6902504E	126,66	8431206694021	17,42	250
CS4/300I	6903004I	159,91	8431206694113	25,45	330
CS4/300E	6903004E	137,73	8431206694120	19,58	300
CS4/400I	6904004I	180,65	8431206694212	28,97	430
CS4/400E	6904004E	157,79	8431206694229	23,10	400

## Consigna grupos / Groups locker / Consigne groupes

Artículo Item Article	Referencia Reference Référence	€/Unidad €/Unit €/Unité	Montaje € / Neto Assembly € / Net Montage € / Net	Cod. EAN EAN Code Code EAN	Peso k Weight k Poids k	Volumen Volume Volume
CS4/251	69002514	148,84	6,50	8431206694038	23,28	0,26
CS4/252	69002524	275,50	13,00	8431206694045	40,70	0,50
CS4/253	69002534	402,16	19,50	8431206694052	58,12	0,73
CS4/254	69002544	528,82	26,00	8431206694069	75,54	0,96
CS4/301	69003014	159,91	6,50	8431206694137	25,45	0,31
CS4/302	69003024	297,64	13,00	8431206694144	45,03	0,59
CS4/303	69003034	435,37	19,50	8431206694151	64,61	0,87
CS4/304	69003044	573,10	26,00	8431206694168	84,19	1,15
CS4/401	69004014	180,65	6,50	8431206694236	28,97	0,40
CS4/402	69004024	338,44	13,00	8431206694243	52,07	0,78
CS4/403	69004034	496,23	19,50	8431206694250	75,17	1,15



## Consignas / lockers / Consignes

Artículo Item Article	Referencia Reference Référence	€/ Unidad €/ Unit €/ Unité	Cod. EAN EAN Code Code EAN	Peso k Weight k Poids k	Ancho Width Largueur
CS5/250I	6902505I	162,06	8431206695011	24,36	280
CS5/250E	6902505E	139,20	8431206695028	18,50	250
CS5/300I	6903005I	174,19	8431206695110	26,43	330
CS5/300E	6903005E	151,33	8431206695127	20,57	300
CS5/400I	6904005I	190,65	8431206695219	30,58	430
CS5/400E	6904005E	167,79	8431206695226	24,72	400

## Consigna grupos / Groups locker / Consigne groupes

Artículo Item Article	Referencia Reference Référence	€/ Unidad €/ Unit €/ Unité	Montaje € / Neto Assembly € / Net Montage € / Net	Cod. EAN EAN Code Code EAN	Peso k Weight k Poids k	Volúmen Volume Volume
CS5/251	69002515	162,06	7,25	8431206695035	24,36	0,26
CS5/252	69002525	301,26	14,50	8431206695042	42,86	0,50
CS5/253	69002535	440,46	21,75	8431206695059	61,36	0,73
CS5/254	69002545	579,66	29,00	8431206695066	79,86	0,96
CS5/301	69003015	174,19	7,25	8431206695134	26,43	0,31
CS5/302	69003025	325,52	14,50	8431206695141	47,00	0,59
CS5/303	69003035	476,85	21,75	8431206695158	67,57	0,87
CS5/304	69003045	628,18	29,00	8431206695165	88,14	1,15
CS5/401	69004015	190,65	7,25	8431206695233	30,58	0,40
CS5/402	69004025	358,44	14,50	8431206695240	55,30	0,78
CS5/403	69004035	526,23	21,75	8431206695257	80,02	1,15





## Consignas / lockers / Consignes

Artículo Item Article	Referencia Reference Référence	€/Unidad €/Unit €/Unité	Cod. EAN EAN Code Code EAN	Peso k Weight k Poids k	Ancho Width Largueur
CS6/250I	6902506I	170,69	8431206696018	25,46	280
CS6/250E	6902506E	147,83	8431206696025	19,60	250
CS6/300I	6903006I	183,50	8431206696117	27,72	330
CS6/300E	6903006E	160,64	8431206696124	21,86	300
CS6/400I	6904006I	200,66	8431206696216	32,24	430
CS6/400E	6904006E	177,80	8431206696223	26,37	400

## Consigna grupos / Groups locker / Consigne groupes

Artículo Item Article	Referencia Reference Référence	€/Unidad €/Unit €/Unité	Montaje € / Neto Assembly € / Net Montage € / Net	Cod. EAN EAN Code Code EAN	Peso k Weight k Poids k	Volumen Volume Volume
CS6/251	69002516	170,69	8,00	8431206696032	25,46	0,26
CS6/252	69002526	318,52	16,00	8431206696049	45,06	0,50
CS6/253	69002536	466,35	24,00	8431206696056	64,66	0,73
CS6/254	69002546	614,18	32,00	8431206696063	84,26	0,96
CS6/301	69003016	183,50	8,00	8431206696131	27,72	0,31
CS6/302	69003026	344,14	16,00	8431206696148	49,58	0,59
CS6/303	69003036	504,78	24,00	8431206696155	71,44	0,87
CS6/304	69003046	665,42	32,00	8431206696162	93,30	1,15
CS6/401	69004016	200,66	8,00	8431206696230	32,24	0,40
CS6/402	69004026	378,46	16,00	8431206696247	58,61	0,78
CS6/403	69004036	556,26	24,00	8431206696254	84,98	1,15



# Sistema de inicial y extensiones

Start and add-on system / Système d'initial et extensions

## Consignas / Lockers / Consignes

Artículo Item Article	Referencia Reference Référence	€/Unidad €/Unit €/Unité	Cod. EAN EAN Code Code EAN	Peso k Weight k Poids k	Ancho Width Largueur
CS8/250I	6902508I	187,94	8431206698012	27,42	280
CS8/250E	6902508E	165,08	8431206698029	21,55	250
CS8/300I	6903008I	202,12	8431206698111	29,99	330
CS8/300E	6903008E	179,26	8431206698128	24,13	300
CS8/400I	6904008I	220,67	8431206698210	35,16	430
CS8/400E	6904008E	197,81	8431206698227	29,29	400

## Consigna grupos / Group lockers / Consigne groupes

Artículo Item Article	Referencia Reference Référence	€/Unidad €/Unit €/Unité	Montaje € / Neto Assembly € / Net Montage € / Net	Cod. EAN EAN Code Code EAN	Peso k Weight k Poids k	Volúmen Volume Volume
CS8/251	69002518	187,94	9,50	8931206698036	27,42	0,26
CS8/252	69002528	353,02	19,00	8931206698043	48,97	0,50
CS8/253	69002538	518,10	28,50	8931206698050	70,52	0,73
CS8/254	69002548	683,18	38,00	8931206698067	92,07	0,96
CS8/301	69003018	202,12	9,50	8931206698135	29,99	0,31
CS8/302	69003028	381,38	19,00	8931206698142	54,12	0,59
CS8/303	69003038	560,64	28,50	8931206698159	78,25	0,87
CS8/304	69003048	739,90	38,00	8931206698166	102,38	1,15
CS8/401	69004018	220,67	9,50	8931206698234	35,16	0,40
CS8/402	69004028	418,48	19,00	8931206698241	64,45	0,78
CS8/403	69004038	616,29	28,50	8931206698258	93,74	1,15



## Consignas / lockers / Consigne

Artículo Item Article	Referencia Reference Référence	€/Unidad €/Unit €/Unité	Cod. EAN EAN Code Code EAN	Peso k Weight k Poids k	Ancho Width Largeur
CS10/250I	69025010I	205,19	8431206699019	29,96	280
CS10/250E	69025010E	182,33	8431206699026	24,09	250
CS10/300I	69030010I	220,76	8431206699118	32,95	330
CS10/300E	69030010E	197,90	8431206699125	27,08	300
CS10/400I	69040010I	240,67	8431206699217	38,93	430
CS10/400E	69040010E	217,81	8431206699224	33,06	400

## Consigna grupos / Groups locker / Consigne groupes

Artículo Item Article	Referencia Reference Référence	€/Unidad €/Unit €/Unité	Montaje € / Neto Assembly € / Net Montage € / Net	Cod. EAN EAN Code Code EAN	Peso k Weight k Poids k	Volúmen Volume Volume
CS10/251	690025110	205,19	11,00	8431206699033	29,96	0,26
CS10/252	690025210	387,52	22,00	8431206699040	54,06	0,50
CS10/253	690025310	569,85	33,00	8431206699057	78,16	0,73
CS10/254	690025410	752,18	44,00	8431206699064	102,26	0,96
CS10/301	690030110	220,76	11,00	8431206699132	32,95	0,31
CS10/302	690030210	418,66	22,00	8431206699149	60,03	0,59
CS10/303	690030310	616,56	33,00	8431206699156	87,11	0,87
CS10/304	690030410	814,46	44,00	8431206699163	114,19	1,15
CS10/401	690040110	240,67	11,00	8431206699231	38,93	0,40
CS10/402	690040210	458,48	22,00	8431206699248	71,99	0,78
CS10/403	690040310	676,29	33,00	8431206699255	105,05	1,15

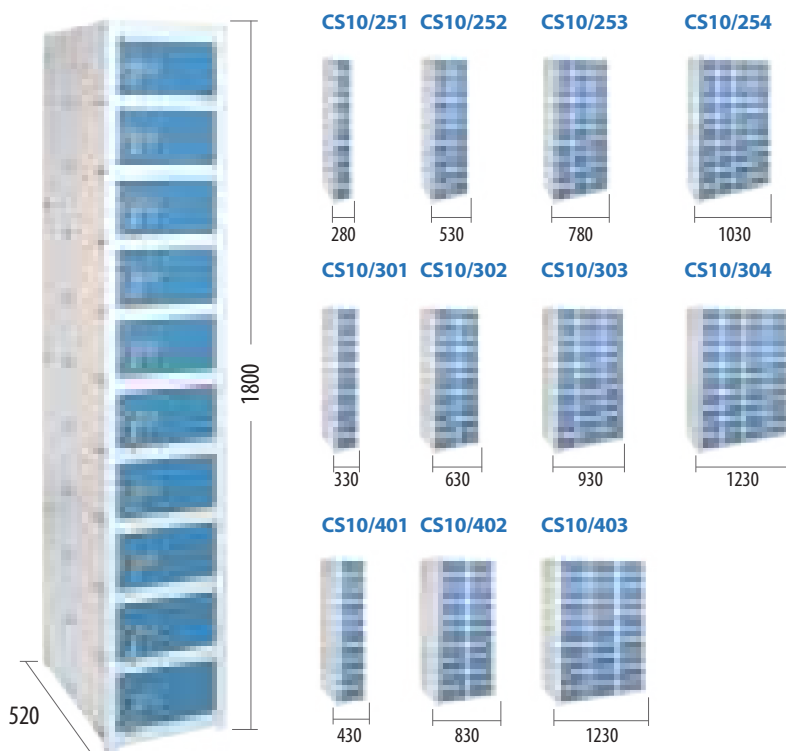

# Sistema de inicial y extensiones

Start and add-on system / Système d'initial et extensions



## Techos inclinados / Sloping tops / Coiffes inclinées

Artículo Item Article	Referencia Reference Référence	€/Unidad €/Unit €/Unité	Montaje € / Neto Assembly € / Net Montage € / Net	Cod. EAN EAN Code Code EAN	Peso k Weight k Poids k	Ancho Width Largueur	Volúmen Volume Volume
TI250	69TI0125	25,82	1,50	8431206690412	1,90	250	-
TI300	69TI0130	26,91	1,50	8431206690429	2,08	300	-
TI400	69TI0140	29,09	1,50	8431206690436	2,45	400	-

RAL 7035 Gris / Grey / Gris



## Patas / Legs / Pieds

Artículo Item Article	Referencia Reference Référence	€/Unidad €/Unit €/Unité	Montaje € / Neto Assembly € / Net Montage € / Net	Cod. EAN EAN Code Code EAN	Peso k Weight k Poids k	Ancho Width Largueur	Volúmen Volume Volume
PT251	69PT0251	20,44	Soldado	8431206692201	2,37	220	0,02
PT252	69PT0252	26,38	Soldado	8431206694700	3,06	470	0,03
PT253	69PT0253	32,32	Soldado	8431206697206	3,75	720	0,05
PT254	69PT0254	38,26	Soldado	8431206699705	4,44	970	0,07
PT301	69PT0301	21,63	Soldado	8431206692706	2,51	270	0,02
PT302	69PT0302	28,76	Soldado	8431206695707	3,34	570	0,04
PT303	69PT0303	35,89	Soldado	8431206698708	4,17	870	0,06
PT304	69PT0304	43,02	Soldado	8431206698715	5,00	1170	0,08
PT401	69PT0401	24,00	Soldado	8431206693703	2,79	370	0,03
PT402	69PT0402	33,50	Soldado	8431206697701	3,89	770	0,05
PT403	69PT0403	43,00	Soldado	8431206697718	5,00	1170	0,08

RAL 7035 Gris / Grey / Gris

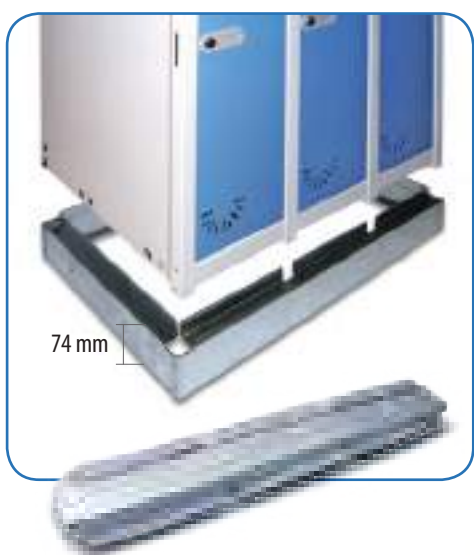

## Zócalos / Bases / Socles

Artículo Item Article	Referencia Reference Référence	€/Unidad €/Unit €/Unité	Montaje € / Neto Assembly € / Net Montage € / Net	Cod. EAN EAN Code Code EAN	Peso k Weight k Poids k	Ancho Width Largueur	Volúmen Volume Volume
ZC251	69ZC0251	23,92	1,35	8431206692805	2,53	280	-
ZC252	69ZC0252	33,49	1,35	8431206695301	3,35	530	-
ZC253	69ZC0253	43,06	1,35	8431206697800	4,18	780	-
ZC254	69ZC0254	52,63	1,35	8431206697817	5,01	1030	-
ZC301	69ZC0301	24,64	1,35	8431206693307	2,69	330	-
ZC302	69ZC0302	34,50	1,35	8431206696308	3,68	630	-
ZC303	69ZC0303	44,36	1,35	8431206699309	4,68	930	-
ZC304	69ZC0304	54,22	1,35	8431206699316	5,67	1230	-
ZC401	69ZC0401	26,13	1,35	8431206694304	3,02	430	-
ZC402	69ZC0402	36,57	1,35	8431206698302	4,34	830	-
ZC403	69ZC0403	47,01	1,35	8431206698319	5,67	1230	-

Galvanizado / Galvanized / Galvanisée

## Cerraduras / Locks / Serrures

Artículo Item Article	Referencia Referencia Référence	€/Unidad €/Unit €/Unité	Cod.EAN EAN Code Code EAN
Cerradura de cilindro cromada (dos llaves) / Chrome cylinder lock (two keys) / Serrure à clé (deux clés)	69000001	4,08	8431206690016
Cerradura aparejada (pareja de dos) / Coupled lock (pairs) / Serrure couplée (par deux)*	69000002	10,38	8431206690023
Cerradura amaestrada / Master-key lock / Serrure à clé maitresse	69000003	5,98	8431206690030
Llave maestra / Master key / Passe-partout général	69000004	5,95	8431206690047
Cerradura de combinación de 4 ruelas / 4-digit combination lock / Serrure à combinaison avec 4 chiffres	69000007	Consultar	8431206690078
Cerradura de candado (candado no incluido) / Padlock (padlock not included) / Serrure à cadenas (cadenas non fourni)*	69000008	6,97	8431206690085
Cerradura de monedero / Coin operated-lock / Serrure à monnaie**	69000012	29,46	8431206690122
Llave maestra de cerradura de monedero / Coin operated-lock Master Key / Clé passe-partout pour serrure à monnaie	69000013	6,75	8431206690139
Llave extractora de monedero / Coin extractor key / Clé d'extraction pour serrure à monnaie	69000014	6,75	8431206690146
Cajetín depósito de monedas / Coin collecting box / Caisse de dépôt de monnaie	69000015	52,30	8431206690153

\* Cerradura aparejada, otros aparejamientos, consultar / Grey Rigged lock, other rigging, Consult. / Antivol gréé, autre gréement, consulter.

\*\* Las cerraduras de candado y monedero no llevan etiquetero identificador / Padlock and coin locks do not have an identifier label / Les cadenas et les serrures à pièces n'ont pas d'étiquette d'identification



**Cerradura de cilindro cromada**  
Chrome cylinder lock  
Serrure à clé

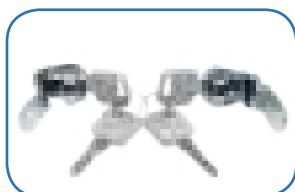

**Cerradura aparejada**  
Coupled lock  
Serrure couplée

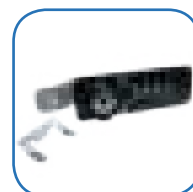

**Cerradura de combinación 4 ruelas**  
4-digit combination lock  
Serrure à combinaison avec 4 chiffres



**Cerradura de candado**  
Coupled lock  
Serrure à cadenas

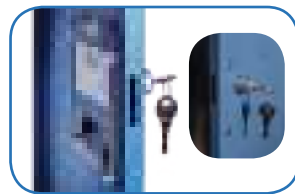

**Cerradura de monedero**  
Coin operated-lock  
Monnayeur

1€



**Cajetín depósito de monedas**  
Coin collecting box  
Caisse de dépôt de monnaie

## Accesorios / Accessories / Accessoires

Artículo Item Article	Referencia Referencia Référence	€/Envase €/Pack €/Emballage	Cod.EAN EAN Code Code EAN
Etiquetero identificador (10 uds.) / Labeller Identifier / Identifiant de l'étiqueteur	69000040	20,20	-
Eje puerta corto (10 uds.) / Short door shaft / Axe de porte court	69000041	2,90	-
Eje puerta largo (10 uds.) / Long door shaft / Axe de porte long	69000042	8,10	-
Muelle (10 uds.) / Spring / Ressort	69000043	2,40	-
Pasador (10 uds.) / Pin / Goupille	69000044	9,20	-



**Etiquetero identificador**  
Labeller Identifier  
Identifiant de l'étiqueteur



**Eje puerta corto**  
Short door shaft  
Axe de porte court

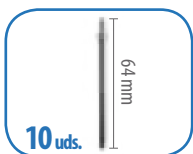

**Eje puerta largo**  
Long door shaft  
Axe de porte long

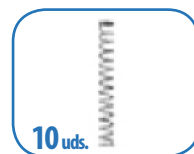

**Muelle**  
spring  
Ressort



**Pasador**  
Pin  
Goupille

## Divisor vertical y balda / Vertical divider and shelf / Séparateur vertical et étagère

Artículo Item Article	Referencia Referencia Référence	€/Unidad €/Unit €/Unité	Montaje € / Neto Assembly € / Net Montage € / Net	Cod. EAN EAN Code Code EAN	Peso k Weight k Poids k
Divisor vertical (1320 h) Vertical divider (1320 h) Séparateur vertical (1320 h)	69090001	19,99	1,50	8431206690191	3,61
Divisor vertical (1520 h) Vertical divider (1520 h) Séparateur vertical (1520 h)	69090002	20,89	1,50	8431206690207	4,13
Balda divisor vertical (300 mm) Vertical divider (300 mm) Séparateur vertical (300 mm)	69090003	9,41	-	8431206690214	1,05
Balda divisor vertical 400 mm) Vertical divider (400 mm) Séparateur vertical (400 mm)	69090004	9,83	-	8431206690221	1,26

Galvanizado / Galvanized / Galvanisée



**Divisor vertical**  
Vertical divider / Séparateur vertical  
Ref: 69090001

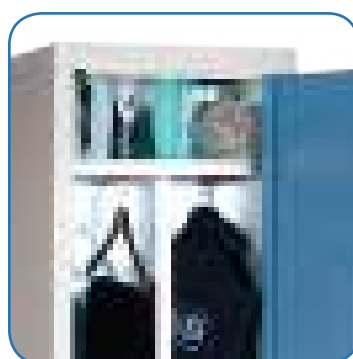

**Balda divisor vertical**  
Vertical shelf / Tablette vertical  
Ref: 69090003 (300 mm) / 69090004 (400 mm)



**Divisor vertical**  
Vertical divider / Séparateur vertical  
Ref: 69090002

## Balda adicional / Additional shelf / Étagère supplémentaire

Artículo Item Article	Referencia Referencia Référence	€/Unidad €/Unit €/Unité	Montaje € / Neto Assembly € / Net Montage € / Net	Cod. EAN EAN Code Code EAN	Peso k Weight k Poids k
Balda adicional 250 mm (AR) Extra shelf 250 mm (AR) Tablette additionnelle 250 mm (AR)	69090250	7,68	-	8431206690221	0,92
Balda adicional 300 mm (AR) Extra shelf 300 mm (AR) Tablette additionnelle 300 mm (AR)	69090300	8,41	-	8431206690238	1,06
Balda adicional 400 mm (AR) Extra shelf 400 mm (AR) Tablette additionnelle 400 mm (AR)	69090400	8,83	-	8431206690245	1,34

Galvanizado / Galvanized / Galvanisée



## Embellecedor lateral / Side trim / Garniture latérale

Artículo Item Article	Referencia Referencia Référence	€/Unidad €/Unit €/Unité	Montaje € / Neto Assembly € / Net Montage € / Net	Cod. EAN EAN Code Code EAN	Peso k Weight k Poids k
Embellecedor lateral 1800H (Azul RAL 5014) Side trim 1800 H (Blue 5014 Ral) Enjoliveur latéral 1800H (Blue RAL 5014)	69001800AZ	32,43	1,50	8431206690252	5,95
Embellecedor lateral 1800H (Gris RAL 7035) Side trim 1800 H (Grey 7035 Ral) Enjoliveur latéral 1800H (Gris RAL 7035)	69001800GR	32,43	1,50	8431206690269	5,95



**RAL 5014 Azul**  
Blue  
Bleu



**RAL 7035 Gris**  
Grey  
Gris

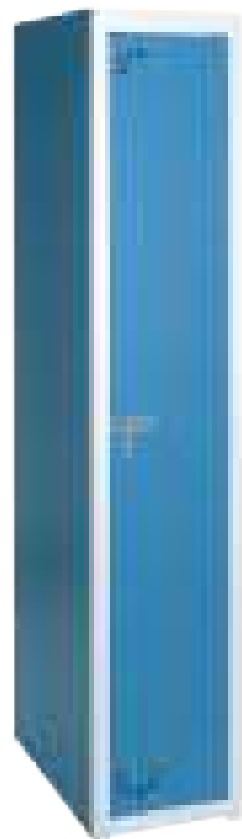

**Embellecedor lateral azul**  
Side trim blue / Enjoliveur latéral bleu

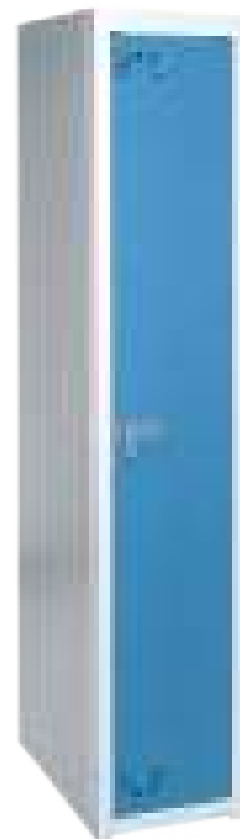

**Embellecedor lateral gris**  
Side trim grey / Enjoliveur latéral gris



**Ranura buzón**  
Mailbox slot / Rainure pour boîte à lettres

## Ranura de buzón / Mailbox slot / Emplacement de boîte aux lettres

Artículo Item Article	Referencia Referencia Référence	€/Unidad €/Unit €/Unité	Cod. EAN EAN Code Code EAN
Ranura buzón 132 Mailbox slot Rainure boîte aux lettres	69000028	3,60	8431206690283
Ranura buzón 182 Mailbox slot Rainure boîte aux lettres	69000029	3,60	8431206690290
Ranura buzón 282 Mailbox slot Rainure boîte aux lettres	69000030	3,60	8431206690306



desarrollamos sus ideas....consúltenos

✉ [dpto.proyectos@estanteriasjomasi.com](mailto:dpto.proyectos@estanteriasjomasi.com)

## Bancos / Benches / Bancs



Artículo Item Article	Referencia Reference Référence	€/Unidad €/Unit €/Unité	Montaje € / Neto Assembly € / Net Montage € / Net	Cod. EAN EAN Code Code EAN	Peso k Weight k Poids k	Perchas Hooks Porte-manteaux	Volúmen* Volume Volume
BD100BS	69BD100BS	123,30	3,75	8431206692102	9,79	-	0,16
BD150BS	69BD150BS	155,56	4,95	8431206692157	14,80	-	0,25
BD200BS	69BD200BS	218,15	4,95	8431206692201	17,54	-	0,33
BD100AS	69BD100AS	218,93	5,25	8431206694106	16,59	4	0,66
BD150AS	69BD150AS	283,33	7,20	8431206694151	25,00	6	0,99
BD200AS	69BD200AS	345,92	7,20	8431206694205	28,72	8	1,33
BD100RS	69BD100RS	243,89	6,25	8431206695103	17,60	4	0,70
BD150RS	69BD150RS	321,49	9,35	8431206695158	26,51	6	1,06
BD200RS	69BD200RS	392,48	9,35	8431206695202	30,24	8	1,40

\* Montado / assembled / assemblés



Artículo / Item / Article: BD100AS / BD150AS / BD200AS

### El buen gusto resalta la vista.

Los listones de pino barnizado en combinación con una estructura de tubo de acero, pintada en un color suave y cálido (gris RAL 7035), consigue que sea un elemento ideal para lograr ambientes agradables.

### Good taste at a glance.

The varnished pine slats combined with a steel tube structure, painted in a soft colour (grey RAL 7035) provides an ideal element that enhances and helps to achieve a pleasant environment.

### Le bon goût saute aux yeux.

Les lattes de pin vernis combinées à la structure en tube d'acier, peinte en couleur tendre et chaude (gris RAL 7035) en font un élément idéal pour créer des ambiances agréables.



Artículo / Item / Article: BD100BS / BD150BS / BD200BS





Artículo / Item / Article: BD100RS / BD150RS / BD200RS

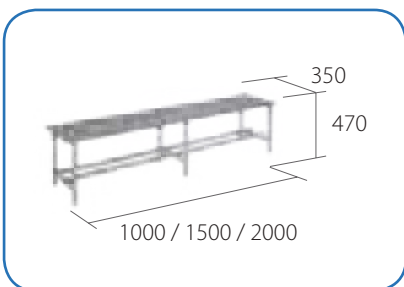

# Bancos desmontados

Unassembled benches / Bancs démontées



## Bancos / Benches / Bancs

Artículo Item Article	Referencia Reference Référence	€/Unidad €/Unit €/Unité	Montaje € / Neto Assembly € / Net Montage € / Net	Cod. EAN EAN Code Code EAN	Peso k Weight k Poids k	Perchas Hooks Porte-manteaux	Volúmen* Volume
BD100AD	69BD100AD	484,98	9,30	8431206697107	28,23	8	1,27
BD150AD	69BD150AD	615,78	12,45	8431206697152	42,55	12	1,91
BD200AD	69BD200AD	751,99	12,45	8431206697206	50,01	16	2,55
BD100RD	69BD100RD	535,17	11,50	8431206698104	33,55	8	1,35
BD150RD	69BD150RD	692,55	17,40	8431206698159	50,52	12	2,03
BD200RD	69BD200RD	845,56	17,40	8431206698203	59,88	16	2,71

\* Montado / assembled / assemblés



Artículo / Item / Article: BD100AD / BD150AD / BD200AD

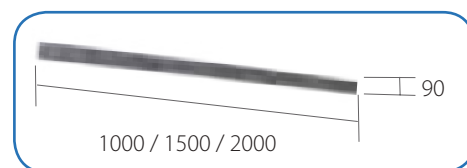

## Colgadores / Hangers / Patères

Artículo Item Article	Referencia Reference Référence	€/Unidad €/Unit €/Unité	Cod. EAN EAN Code Code EAN	Peso k Weight k Poids k	Perchas Hooks Porte-manteaux	Volúmen* Volume
CD1000	69CD1004	46,10	8431206691105	1,07	4	0,01
CD1500	69CD1506	61,24	8431206691150	1,61	6	0,01
CD2000	69CD2008	73,59	8431206691204	2,15	8	0,02

\* Montado / assembled / assemblés



Artículo / Item / Article: BD100RD / BD150RD / BD200RD

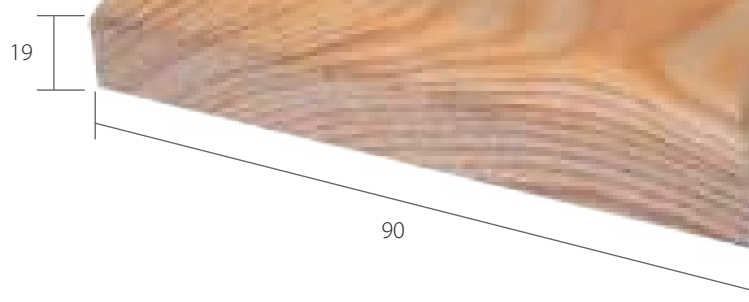

## Serie Venecia

*Armarios metálicos desmontados que se adaptan a cualquier tipo de espacio permitiendo el almacenamiento de material de oficina, archivo y limpieza de la forma más efectiva.*

*Disassembled metal cabinets that adapt to any type of space allowing the storage of office, filing and cleaning supplies in the most effective way.*

*Armoires métalliques démontables qui s'adaptent à tout type d'espace permettant le stockage des fournitures de bureau, de classement et de nettoyage de la manière la plus efficace.*

# 78 - 79

Armario de Limpieza  
Cleaning locker  
Armoire entretien

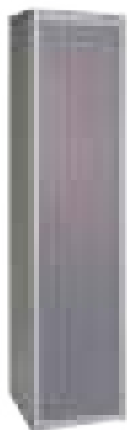
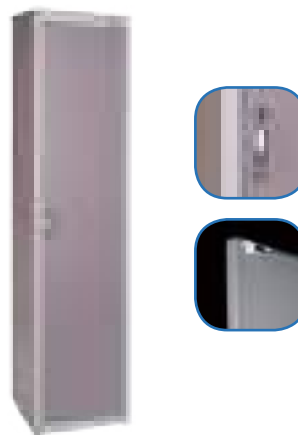

# 80 - 81

Armario de Limpieza  
Cleaning locker  
Armoire entretien

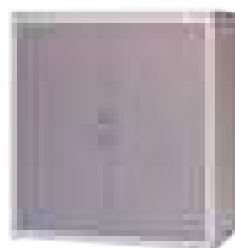

# 82 - 83

Armario de Ordenación  
Tidy storage locker  
Armoire de rangement



# 84 - 85

Armario de Ordenación  
Tidy storage locker  
Armoire de rangement

**Colores estándar**  
Standard colours / Couleurs standards

Cuerpo / Body / Corps



Puerta / Door / Porte

**Otros colores consultar**  
Other colors consult  
Autres couleurs consulter

Pintura texturada poliéster / Paint polyeste textured / Peinture texturé polyester

La familia "Mobiliario para vestuario y colectividades", la resistencia a la oxidación en los artículos de acero pintado, sólo se garantiza para ambientes secos. Para ambientes húmedos consultar con nuestro departamento comercial.

The "Furniture for changing rooms and community buildings", resistance to rusting of the painted steel articles is guaranteed for dry environments. For damp environments please consult with our sales department. Pour la famille "Mobilier pour vestiaire et collectivités", la résistance à l'oxydation des articles en acier peint, n'est garantie qu'en environnements secs. Pour les environnements humides, prière de consulter notre département commercial.

Para pedidos a portes pagados se entiende por material desmontado, salvo que se haya acordado.  
Carriage paid orders are understood to refer to unmounted material, unless mounting has been agreed.  
Pour les commandes à ports payés, le matériel est entendu démonté, sauf accord.

Por razones técnicas de impresión, los colores pueden variar del catálogo con los de nuestros artículos.  
For technical printing reasons the colours indicated in the catalogue may differ from the actual article colours.  
Pour des raisons techniques d'impression, les couleurs de nos articles peuvent varier par rapport à celles du catalogue.

## Armario de limpieza / Cleaning locker / Armoire entretien

Artículo Item Article	Referencia Reference Référence	€/Unidad €/Unit €/Unité	Montaje € / Neto Assembly € / Net Montage € / Net	Cod. EAN EAN Code Code EAN	Peso k Weight k Poids k	Volúmen Volume Volume
SV1800.400/LP	691841LP	141,05	5,95	8431206018018	29,60	0,05
SV1800.500/LP	691851LP	160,05	5,95	8431206018513	33,76	0,07

**SV1800.400/LP (incluye 4 baldas 69395300) – SV1800.500/LP (incluye 1 bada 69495435 y 3 baldas 69495300)**  
 SV1800.400/LP (includes 4 shelves 69395300) – SV1800.500/LP (includes 1 shelf 69495435 and 3 shelves 69495300)  
 SV1800.400/LP (comprend 4 tablettes 69395300) – SV1800.500/LP (comprend 1 tablette 69495435 et 3 tablettes 69495300)

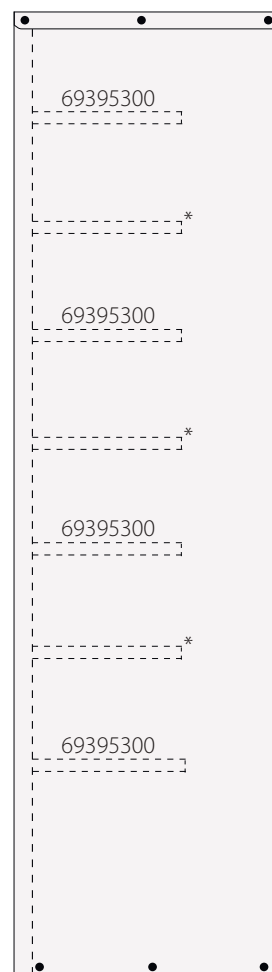
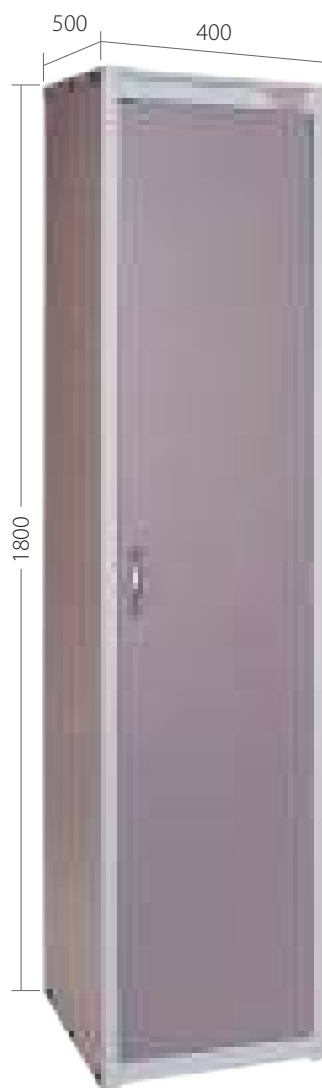

\* **Opcional** / optional / optionnel

Artículo / Item / Article: SV1800.400/LP

Tiempo de montaje / Assembly time / Temps de montage **10'**

### Cerradura Magnética

Magnetic lock / Serrure magnétique

## Balda adicional / Extra Shelf / Tablette Additionnelle

Artículo Item Article	Referencia Reference Référence	€/Unidad €/Unit €/Unité	Cod. EAN EAN Code Code EAN	Peso k Weight k Poids k	Volúmen Volume Volume
SVB0400C	69395300	8,67	8431206690306	0,86	-
SVB0500C	69495300	9,51	8431206690313	1,05	-
SVB0500L	69495435	10,79	8431206690320	1,45	-

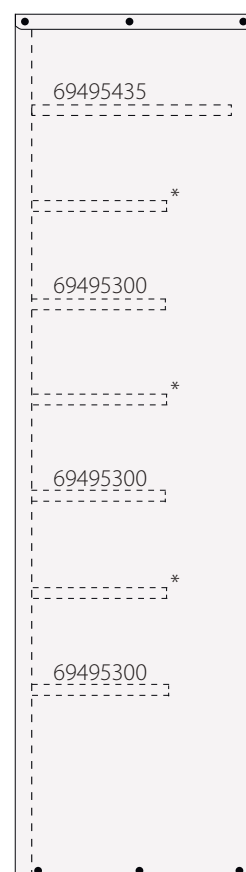

\* **Opcional** / optional / optionnel

Artículo / Item / Article: SV1800.500/LP

Tiempo de montaje / Assembly time / Temps de montage **10'**



**Pestaña de sujeción**  
Fastener tab  
Ergot de fixation



**Grapa de unión**  
Clamp  
Agrafe d'union



**Cierre magnético**  
Magnetic lock  
Fermeture magnétique



**Puerta con refuerzo**  
Reinforced door  
Porte renforcée



**Maneta puerta**  
Door handle  
Poignée de porte



**Eje de puerta**  
Door shaft  
Axe de porte

## Armario de limpieza / Cleaning locker / Armoire entretien

Artículo Item Article	Referencia Reference Référence	€/Unidad €/Unit €/Unité	Montaje € / Neto Assembly € / Net Montage € / Net	Cod. EAN EAN Code Code EAN	Peso k Weight k Poids k	Volúmen Volume Volume
SV1800.400/LPC	691841LPC	138,83	5,95	8431206118411	29,50	0,05
SV1800.500/LPC	691851LPC	157,83	5,95	8431206118510	33,66	0,07
SV1800.500/LPEC	691851LPEC	157,83	7,35	8431206118619	33,56	0,07

SV1800.400/LPC (incluye 4 baldas 69395300) – SV1800.500/LPC (incluye 1 bada 69495435 y 3 baldas 69495300)  
 SV1800.400/LPC (includes 4 shelves 69395300) – SV1800.500/LPC (includes 1 shelf 69495435 and 3 shelves 69495300)  
 SV1800.400/LPC (comprend 4 tablettes 69395300) – SV1800.500/LPC (comprend 1 tablette 69495435 et 3 tablettes 69495300)

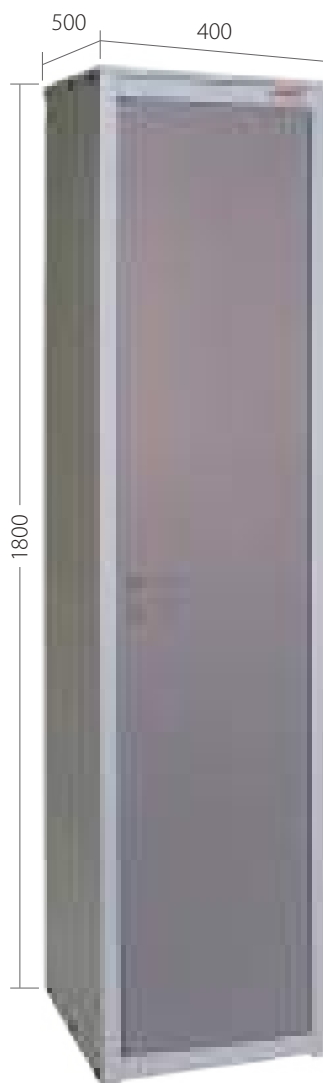

\* Opcional / optional / optionnel

Artículo / Item / Article: SV1800.400/LPC

Tiempo de montaje / Assembly time / Temps de montage **10'**

**Cerradura con llave**  
lock with key / serrure avec clé



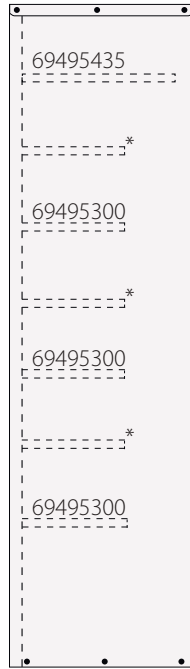

\* **Opcional** / optional / optionnel

**Artículo** / Item / Article: SV1800.500/LPC

**Tiempo de montaje** / Assembly time / Temps de montage **10'**

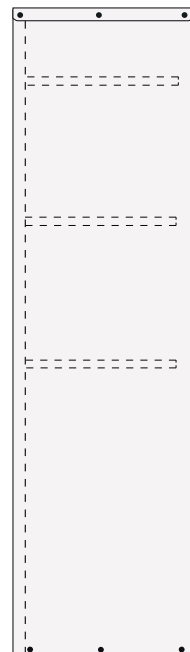

**Artículo** / Item / Article: SV1800.500/LPEC

**Tiempo de montaje** / Assembly time / Temps de montage **10'**



**Pestaña de sujeción**  
Fastener tab  
Ergot de fixation



**Grapa de unión**  
Clamp  
Agrafe d'union



**Puerta con refuerzo**  
Reinforced door  
Porte renforcée



**Cerradura con llave**  
Lock with key  
Serrure avec clé



**Eje de puerta**  
Door shaft  
Axe de porte

## Armario de ordenación

Tidy storage locker / Armoire de rangement

Artículo Item Article	Referencia Reference Référence	€/Unidad €/Unit €/Unité	Montaje € / Neto Assembly € / Net Montage € / Net	Cod. EAN EAN Code Code EAN	Peso k Weight k Poids k	Volúmen Volume Volume
SV0900.800/OR	6909420R	138,48	7,95	8431206009023	23,21	0,03
SV1800.800/OR	6918420R	256,23	9,95	8431206018025	44,92	0,06

SV0900.800/OR (incluye 1 balda 69795435) – SV1800.800/OR (incluye 1 bada 69795435 y 3 baldas 69795300)  
 SV0900.800/OR (includes 1 shelf 69795435) – SV1800.800/OR (includes 1 shelf 69795435 and 3 shelves 69795300)  
 SV0900.800/OR (comprend 1 tablette 69795435) – SV1800.800/OR (comprend 1 tablette 69795435 et 3 tablettes 69795300)



Artículo / Item / Article: SV1800.800/OR

Tiempo de montaje / Assembly time / Temps de montage **15'**

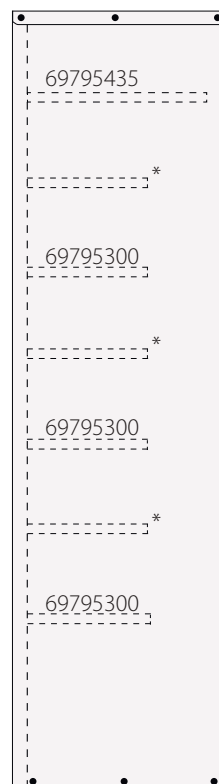

\* Opcional / optional / optionnel

## Cerradura Magnética

Magnetic lock / Serrure magnétique



Artículo / Item / Article: SV0900.800/OR

Tiempo de montaje / Assembly time / Temps de montage **10'**

### Balda adicional / Extra Shelf / Tablette Additionnelle

Artículo Item Article	Referencia Reference Référence	€/Unidad €/Unit €/Unité	Cod. EAN EAN Code Code EAN	Peso k Weight k Poids k	Volúmen Volume Volume
SVB0800C	69795300	12,05	8431206690337	1,63	-
SVB0800L	69795435	13,99	8431206690344	2,25	-



**Pestaña de sujeción**  
Fastener tab  
Ergot de fixation



**Grapa de unión**  
Clamp  
Agrafe d'union



**Cierre magnético**  
Magnetic lock  
Fermeture magnétique



**Puerta con refuerzo**  
Reinforced door  
Porte renforcée



**Maneta puerta**  
Door handle  
Poignée de porte



**Eje de puerta**  
Door shaft  
Axe de porte

## Armario de ordenación

Tidy storage locker / Armoire de rangement

Artículo Item Article	Referencia Reference Référence	€/Unidad €/Unit €/Unité	Montaje €/Neto Assembly €/Net Montage €/Net	Cod. EAN EAN Code Code EAN	Peso k Weight k Poids k	Volúmen Volume Volume
SV0900.800/ORC	6909420RC	151,92	7,95	8431206109020	23,28	0,03
SV1800.800/ORC	6918420RC	270,29	9,95	8431206118022	44,99	0,06

**SV0900.800/ORC (incluye 1 balda 69795435) – SV1800.800/ORC (incluye 1 balda 69795435 y 3 baldas 69795300)**  
 SV0900.800/ORC (includes 1 shelf 69795435) – SV1800.800/ORC (includes 1 shelf 69795435 and 3 shelves 69795300)  
 SV0900.800/ORC (comprend 1 tablette 69795435) – SV1800.800/ORC (comprend 1 tablette 69795435 et 3 tablettes 69795300)



Artículo / Item / Article: SV1800.800/ORC

Tiempo de montaje / Assembly time / Temps de montage **15'**

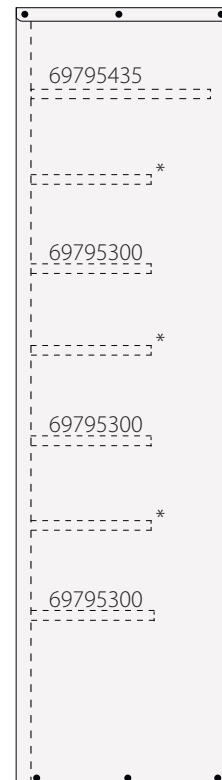

\* Opcional / optional / optionnel

## Cerradura con llave

lock with key / serrure avec clé

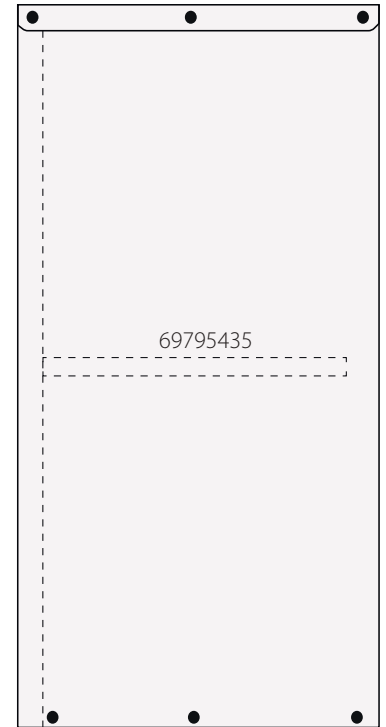

**Artículo / Item / Article:** SV0900.800/ORC

**Tiempo de montaje / Assembly time / Temps de montage** 10'



**Pestaña de sujeción**  
Fastener tab  
Ergot de fixation



**Grapa de unión**  
Clamp  
Agrafe d'union



**Puerta con refuerzo**  
Reinforced door  
Porte renforcée



**Sistema falleba 2 puntos**  
2 point espagnolette system  
Système de crémonne 2 points



**Cerradura con llave**  
Lock with key  
Serrure avec clé



**Eje de puerta**  
Door shaft  
Axe de porte

## Accesorios / Accessories / Accessoires

Artículo Item Article	Referencia Referencia Référence	€/ Unidad €/ Unit €/ Unité	Cod.EAN EAN Code Code EAN
Cerradura de cilindro cromada (dos llaves) / Chrome cylinder lock (two keys) / Serrure à clé (deux clés)	69000001	4,08	8431206690016
Cerradura de falleba (2 puntos de cierre) / Espagnolette lock (2 locking points) / Serrure à espagnolette (2 points à clé)	69000025	19,49	8431206690252
Varilla falleba 420 mm (2 uds.) / Espagnolette rod 420 mm / Tringle 420 mm pour serrure à espagnolette	69000026	6,56	8431206690269
Varilla falleba 870 mm (2 uds.) / Espagnolette rod 870 mm / Tringle 870 mm pour serrure à espagnolette	69000027	7,16	8431206690276
Maneta (1 ud. + 2 tornillos) / Handle (1 unit + 2 screws) / Poignée (1 unité + 2 visés)	69000031	4,62	8431206690313
Iman (2 uds.) / Magnet / Aimant	69000032	1,68	8431206690320



**Cerradura cilindro cromada**  
Chrome cylinder lock  
Serrure à clé

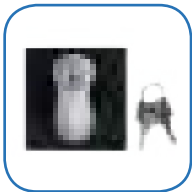

**Cerradura de falleba**  
Espagnolette lock  
Serrure à espagnolette

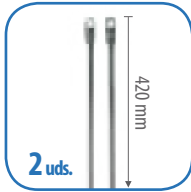

**2 uds.**  
**Varilla falleba 420 mm**  
Espagnolette rod 420 mm  
Tringle espagnolette 420 mm

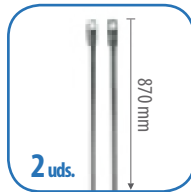

**2 uds.**  
**Varilla falleba 870 mm**  
Espagnolette rod 820 mm  
Tringle espagnolette 870 mm

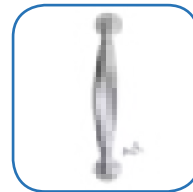

**Maneta**  
Handle  
Poignée



**2 uds.**  
**Imán**  
Magnet  
Aimant



---

---

---

---

---

---

---

---

---

---

---

---

---

---

---

---

---

---

---

---

---

---

---

---

---



---



---



---



---



---



---



---



---



---



---



---



---



---



---



---



---



---



---



---



---



---



---



---



---



---



---



---

*e s t a n t e r í a s*  
**JOMASI**  
SOCIEDAD LIMITADA



FABRICA

Parque Industrial "El Polígono" Avda. Río Ebro, 18  
50410 Cuarte de Huerva (Zaragoza) España  
Teléfono (+34) 976 504 103  
info@estanteriasjomasi.com



DELEGACIÓN CENTRO

Polígono Industrial Villaverde  
C/ Laguna del Marquesado 24, Nave 26 B  
28021 Villaverde (Madrid) España  
Teléfono (+34) 911 907 025  
info@comercialskm.es

ISO 9001  
BUREAU VERITAS  
Certification



ISO 14001  
BUREAU VERITAS  
Certification



ASOCIADO

 **AIDIMME**   
INSTITUTO TECNOLÓGICO